

**EN OWNER'S MANUAL /**

Instructions for Assembly '8 Ft Top'  
Size 8Ft x 6Ft / 2.6 m x 1.8 m  
Ver: 1.0

**FR MANUEL D'INSTRUCTION /**

Instructions pour l'Assemblage '8 Pieds Top'  
Dimension 8Pieds x 6Pieds / 2.6 Mètre x 1.8 Mètre  
Ver: 1.0

**DE Benutzerhandbuch /**

Montageanleitung '8 Ft Top'  
Größe: 8Ft x 6Ft / 2.6 m x 1.8 m  
Ver: 1.0

**ES MANUAL DEL PROPIETARIO /**

Instrucciones de montaje '8 Pies Top'  
Tamaño 8Pies x 6Pies / 2.6 Metros x 1.8 Metros  
Ver: 1.0

**PT MANUAL DO PROPRIETARIO /**

Instruções de montagem '8 pés Top'  
Tamanho 8pés x 6pés / 2.6 Metro x 1.8 Metro  
Ver: 1.0

**NL Gebruiksaanwijzing voor eigenaar /**

Instructies voor bouw '8Voet Top'  
Maat 8 voet x 6 voet / 2.6 Meter x 1.8 Meter  
Versie: 1.0

**CS Příručka uživatele /**

Návod k montáži '8 Stopy Top'  
Velikost 8 Stopy x 6 Stopy / 2.6 Metr x 1.8 Metr  
Verze : 1.0

**SK NÁVOD PRE UŽÍVATEĽA /**

Návod na zloženie '8 Stopa Top'  
Velkost' 8Stopa x 6Stopa / 2.6 m x 1.8 m  
Pozri: 1.0

**SL PRIROČNIK ZA LASTNIKA /**

Navodila za montažo '8 Čevljev Top'  
Velikost 8Čevljev x 6Čevljev / 2.6 Metrov x 1.8 Metrov  
Razl: 1.0

**HR Gazdinski Priručnik /**

Instrukcije za skupštine '8 Stopalo Top'  
Veličina 8 Stopalo x 6 Stopalo / 2.6 Metar x 1.8 Metar  
Ver: 1.0

**HU FELHASZNÁLÓI KÉZIKÖNYV /**

Útmutató az összeszereléshez '8 Láb Top'  
8Láb x 6Láb / 2.6 Méter x 1.8 Méter  
1.0 verzió

**SV ÄGARENS MANUAL /**

Monteringsinstruktioner för '8 Fot Top'  
Storlek 8 fot x 6 fot / 2.6 m x 1.8 m  
Version: 1.0

**IT MANUALE DEL PROPRIETARIO /**

Istruzioni per l'assemblaggio '8 Piedi Top'  
Dimensione 8 Piedi x 6 Piedi / 2.6Metri x 1.8Metri  
Versione 1.0

**PL PODRĘCZNIK UŻYTKOWNIKA /**

Instrukcja montażu '8Stopy Top'  
Wymiary 8Stopy x 6Stopy / 2.6 Metr x 1.8 Metr  
Wersja: 1.0

**RO MANUAL DE UTILIZARE /**

Instrucțiuni de asamblare '8 Picioare Top'  
Mărimē 8Picioare x 6Picioare / 2.6 Metri x 1.8 Metri  
Ver: 1.0

**BG РЪКОВОДСТВО ЗА ПРИТЕЖАТЕЛЯ /**

Инструкции за сглобяване '8 Фуџа Top'  
Размер 8 Фуџа x 6 Фуџа / 2.6 Метра x 1.8 Метра  
Версия: 1.0

**TR KULLANIM KILAVUZU /**

Montaj Talimatları '8 Fit Top'  
8Fit x 6Fit / 2.6 m x 1.8m  
Sürüm: 1.0

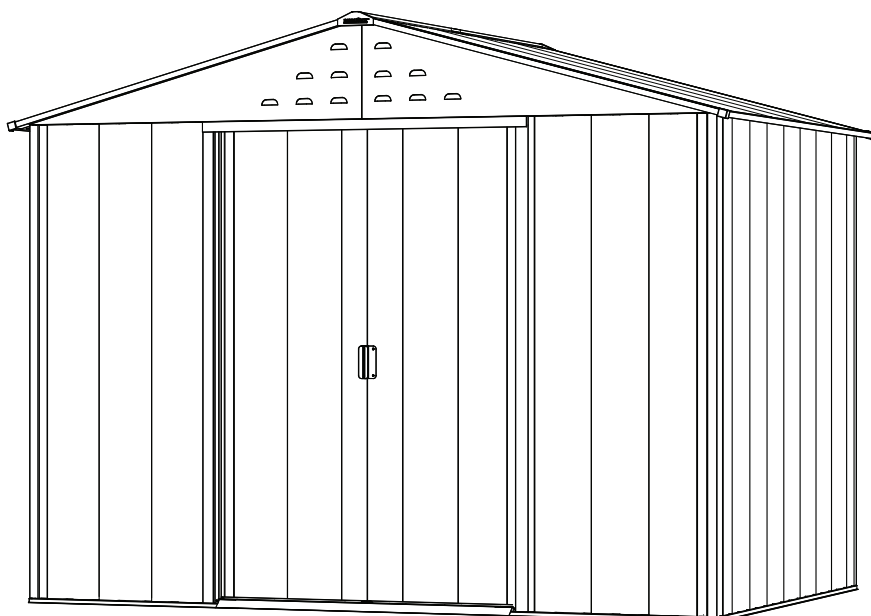

Type Approved  
Safety  
Regular Production  
Surveillance



www.tuv.com  
ID 1419055646



EN

## Building Dimensions :

Approximate Size	Storage		Exterior Dimension				Interior Dimension		Door Opening		
	Area	Volume	Base Dimension		Roof Edge to Edge		Wall to Wall				
			inch	cm	inch	cm	inch	cm	inch	cm	
8 Ft x 6 Ft	42 1/4 Sq. Ft	246 1/2 Cu.Ft	Width	99 1/4	252	103	261.6	95 7/8	243.5	40 5/8	103.2
2.6 m x 1.8 m	3.93 Sq.m	6.98 Cu.m	Depth	68 1/4	173.5	72	183	63 1/2	161.2		
			Height			80 1/2	204.5	70	177.8	68 1/8	173

Snow load tested max. 20lbs / sq.foot (As per IP Standard) / 0.5 kN/m<sup>2</sup> [TUV Load tested].

"We recommend to clear snow from the Roof top after each Snowfall."

A snow depth of more than 10 cm can become hazardous!

FR

## Dimensions du bâtiment :

Taille approximative	Stockage		Dimension extérieure				Dimension intérieure		Ouverture de porte		
	Secteur	Volume	Dimension de base		Toit de bord au bord		Mur à mur				
			pouce	cm	pouce	cm	pouce	cm	pouce	cm	
8 Pieds x 6 Pieds	42 1/4 Carré pieds	246 1/2 Pieds cube	Largeur	99 1/4	252	103	261.6	95 7/8	243.5	40 5/8	103.2
2.6 Mètre x 1.8 Mètre	3.93 Mètre carré	6.98 Mètre cube	Profondeur	68 1/4	173.5	72	183	63 1/2	161.2		
			Hauteur			80 1/2	204.5	70	177.8	68 1/8	173

Charge de neige testé max. 20lbs / Carré pieds(conformément à la norme IP) /

0.5 kN/Mètre carré [Testé sous charge TUV].

"Nous recommandons d'enlever la neige du Toit après chaque Enneigement."

Une épaisseur de neige de plus de 10 cm peut devenir dangereux!

DE

## Gebäude Abmessung:

Ungefähre Größe	Speicher		Außen Abmessung				Innen Abmessung		Türöffnung		
	Bereich	Volumen	Fundament Abmessung		Dach Kante bis Kante		( von Wand zu Wand )				
			inch	cm	inch	cm	inch	cm	inch	cm	
8 Ft x 6 Ft	42 1/4 Sq. Ft	246 1/2 Cu.Ft	Breite	99 1/4	252	103	261.6	95 7/8	243.5	40 5/8	103.2
2.6 m x 1.8 m	3.93 Sq.m	6.98 Cu.m	Tiefe	68 1/4	173.5	72	183	63 1/2	161.2		
			Höhe			80 1/2	204.5	70	177.8	68 1/8	173

Schneelast max. getestet. 20lbs /sq.Foot (gem. Standard IP) / 0.5 kN/m<sup>2</sup> [TUV Belastung getestet]

"Wir empfehlen, Schnee von der Dachspitze nach jedem Schneefall zu löschen."

Eine Schneetiefe von mehr als 10 cm kann gefährlich werden!

ES

## Medidas de la caseta:

El Tamaño a proximado	Área de almacenaje		Dimensión exterior				Dimensión interior		Abertura de la puerta		
	Área	Volumen	Dimensión de la base		Borde del tejado al borde		pared a pared				
			Pulgada	cm	Pulgada	cm	Pulgada	cm	Pulgada	cm	
8 Pies x 6Pies	42 1/4 Pies cuadrados	246 1/2 Pies Cúbicos	Anchura	99 1/4	252	103	261.6	95 7/8	243.5	40 5/8	103.2
2.6 Metros x 1.8 Metros	3.93 Metros cuadrados	6.98 Metros Cúbicos	Profundidad	68 1/4	173.5	72	183	63 1/2	161.2		
			Altura			80 1/2	204.5	70	177.8	68 1/8	173

Carga de nieve probado max. 20lbs / Pies cuadrados (según el estándar de IP)/

0.5 kN/Metros cuadrados [Prueba de carga de TUV].

"Se recomienda limpiar la nieve de la azotea después de ca da nevada."

Una profundidad de nieve de más de 10 cm puede llegar a ser peligrosa!

PT

## Área de Construção:

Dimensão aproximada	Área de Arrumação		Dimensão Exterior				Dimensão Interior		Abertura da Porta		
	Área	Volume	Dimensão da base		Amplitude do Telhado		(Parede a Parede)				
			Polegada	centímetro	Polegada	centímetro	Polegada	centímetro	Polegada	centímetro	
8 pés x 6 pés	42 1/4 Pies quadrado	246 1/2 Pies cúbico	Comprimento	99 1/4	252	103	261.6	95 7/8	243.5	40 5/8	103.2
2.6 Metro x 1.8 Metro	3.93 Metro quadrado	6.98Metro cúbico	Profundidade	68 1/4	173.5	72	183	63 1/2	161.2		
			Altura			80 1/2	204.5	70	177.8	68 1/8	173

Carga de neve testado max. 20lbs / Pies quadrado (conforme padrão IP) /

0.5 kN/Metro quadrado [Carga deTUV testado].

"Recomendamos limpar a neve do topo do telhado após cada queda de neve."

Uma profundidade de neve de mais de 10 cm pode tornar-se perigosa!

NL

## Gebouw afmeting:

Benadering Maat	Opslag		Buitenkant afmeting				Binnenkant afmeting		Deur opening		
	Gebied	Volume	Basis afmeting		Dakrand tot rand		Muur tot muur				
			inch	cm	inch	cm	inch	cm	inch	cm	
8 Voet x 6 Voet	42 1/4 Vierkante voet	246 1/2 Kubieke voet	<b>Wijde</b>	99 1/4	252	103	261.6	97 1/2	243.5	40 5/8	103.2
2.6 m x 1.8 m	3.93 Vierkante meter	6.98 Kubieke meter	<b>Diepte</b>	68 1/4	173.5	72	183	63 1/2	161.2		
			<b>Hoogte</b>			80 1/2	204.5	70	177.8	68 1/8	173

Sneeuw belasting getest max. 20lbs / Vierkante voet (volgens het standaard IP-) /  
0.5 kN/Vierkante meter [TUV Load getest].

“We raden aan sneeuw uit het dak te verwijderen na elke sneeuwval.”

Een sneeuwdiepte van meer dan 10 cm kan gevaarlijk worden!

CS

## Budova rozměr

Přibližné rozměry	Skladování		Vnější rozměr				Vnitřní rozměr		Otevírání dveří		
	Plocha	Objem	Základní rozměr		Na okraj střechy edge		zdi ke zdi				
			inch	cm	inch	cm	inch	cm	inch	cm	
8 Stopy x 6 Stopy	42 1/4 Čtvereční Stopy	246 1/2 Krychlový Stopy	<b>Šířka</b>	99 1/4	252	103	261.6	95 7/8	243.5	40 5/8	103.2
2.6 Metr x 1.8 Metr	3.93 Čtvereční metr	6.98 Krychlový Metr	<b>Hloubka</b>	68 1/4	173.5	72	183	63 1/2	161.2		
			<b>Výška</b>			80 1/2	204.5	70	177.8	68 1/8	173

Zkouška zatížení sněhu max. 20lbs / Čtvereční Stopy (podle normy IP) /  
0.5 kN/Čtvereční metr [TUV Test zatížení].

“Doporučujeme odstranit sníh ze střešního krytu po každém sněžení.”

Možná hloubka sněhu větší než 10 cm může být nebezpečná!

SK

## Stavebné rozmer

Približné veľkosti	Sklad		Vonkajší rozmer				Interiér rozmer		Otvorenie dverí		
	Priestor	Objem	Base rozmer		Strešné okraja k okraju		Zdi k múru				
			inch	cm	inch	cm	inch	cm	inch	cm	
8 Stopa x 6 Stopa	42 1/4 Stopa štvorcový	246 1/2 Stopa kubický	<b>Šírka</b>	99 1/4	252	103	261.6	95 7/8	243.5	40 5/8	103.2
2.6 m x 1.8 m	3.93 Meter štvorcový	6.98 Meter kubický	<b>Hĺbka</b>	68 1/4	173.5	72	183	63 1/2	161.2		
			<b>Výška</b>			80 1/2	204.5	70	177.8	68 1/8	173

Testovanie zaťaženia snehu max. 20lbs / Stopa štvorcový (podľa IP štandardu) /  
0.5 kN/Meter štvorcový [Skúšaný zaťaženie TUV].

“Odporúčame odstrániť sneh zo strechy po každej snehu.”

Z hĺbky snehu väčšej ako 10 cm sa môže stať nebezpečné!

SL

## Zidanje obseg

približno velikost	Skladiščenje		zunanji obseg				notranji obseg		vrata predrtina		
	Območje	Prostornina	osnova obseg		streha rob v rob		obdati obzidati				
			cola	cm	cola	cm	cola	cm	cola	cm	
8 Čevljev x 6 Čevljev	42 1/4 Kvadratnih Čevljev	246 1/2 Kubičnih Čevljev	<b>širina</b>	99 1/4	252	103	261.6	95 7/8	243.5	40 5/8	103.2
2.6 Metrov x 1.8 Metrov	3.93 Kvadratnih Metrov	6.98 Kubičnih Metrov	<b>globina</b>	68 1/4	173.5	72	183	63 1/2	161.2		
			<b>višina</b>			80 1/2	204.5	70	177.8	68 1/8	173

Snow obremenitev testiran max. 20lbs / Kvadratnih Čevljev (po standardu IP) /  
0.5 kN/Kvadratnih Metrov [TUV obremenitev preizkušn].

“Priporočamo, da počistite sneg z vrha strehe po vsakem sneženju.”

Z globino snega več kot 10 cm lahko postane nevarno!

HR

## Zgrada dimenzija

Približno određena mjera	Skladištenje		Vanjski dimenzija				Interijer dimenzija		Vrata Open		
	Područje	Svezak	Temeljiti dimenzija		Krov rub to rub		Zidni to zidni		inch	cm	
			inch	cm	inch	cm	inch	cm			
8 Stopalo x 6 Stopalo	42 1/4 Četvornih Stopalo	246 1/2 Kubni Stopalo	Širina	99 1/4	252	103	261.6	95 7/8	243.5	40 5/8	103.2
2.6 Metar x 1.8 Metar	3.93 Četvornih Metar	6.98 Kubni Metar	dubina	68 1/4	173.5	72	183	63 1/2	161.2		
			visina			80 1/2	204.5	70	177.8	68 1/8	173

Testirano opterećenje max.20lbs / Četvornih Stopalo (prema IP standardu) / 0.5 kN/Četvornih Metar [TUV Ispitivanje opterećenja].  
 “Preporučujemo čišćenje snijega s vrha krova nakon svakog snijega.”  
 Nema dubine snijega veće od 10 cm može biti opasna!

HU

## Építési dimenzió

Hozzávetőleges mérete	Tárolás		Külső méret				A belső dimenzió		Ajtónyitás		
	Terület	Mennyiség	Alap dimenzió		Tető élétől él		A fal és a fal		Hüvelyk	cm	
			Hüvelyk	cm	Hüvelyk	cm	Hüvelyk	cm			
8 Láb x 6 Láb	42 1/4 Négyzet Láb	246 1/2 Köb Láb	Szélesség	99 1/4	252	103	261.6	95 7/8	243.5	40 5/8	103.2
2.6 Méter x 1.8 Méter	3.93 Négyzet méter	6.98 Köbméter	Oldalmagasság	68 1/4	173.5	72	183	63 1/2	161.2		
			Magasság			80 1/2	204.5	70	177.8	68 1/8	173

A terhelés max. 20lbs / Négyzet Láb (IP-szabvány szerint) / 0.5 kN/Négyzet méter [TUV terhelés tesztelt].  
 “Javasoljuk, hogy minden hóesést követően tisztítsa meg a havat a tetőtől.”  
 A 10 cm-nél hosszabb hóvastagság veszélyessé válhat!

SV

## Byggnadsdimensioner:

Ungefärlig storlek	Lager		Yttre dimensioner				Inre dimensioner		Dörröppning		
	Area	Volym	Basdimensioner		Tak kant till kant		Vägg till vägg		Tum	cm	
			Tum	cm	Tum	cm	Tum	cm			
8 fot x 6 fot	42 1/4 kvadrat fot	246 1/2 kubik fot	Bredd	99 1/4	252	103	261.6	95 7/8	243.5	40 5/8	103.2
2.6 m x 1.8 m	3.93 kvadratmeter	6.98 kubik meter	Djup	68 1/4	173.5	72	183	63 1/2	161.2		
			Höjd			80 1/2	204.5	70	177.8	68 1/8	173

Snow last testas max. 20lbs / kvadrat fot (enligt IP-standard) / 0.5 kN/kvadratmeter [TUV belastning testade].  
 “Vi rekommenderar att klara snö från taket efter varje snöfall.”  
 Ett snödjup på mer än 10 cm kan bli farligt!

IT

## Dimensioni di Costruzione:

Dimensione approssimativa	Deposito		Dimensione Esterna				Dimensioni Interne		Apertura della Porta		
	Area	Volume	Dimensione della Base		Soffitto da Lato a Lato		Da Muro a Muro		Inches	Centimetri	
			Inches	Centimetri	Inches	Centimetri	Inches	Centimetri			
8 Piedi x 6 Piedi	42 1/4 Piedi Quadrati	246 1/2 Piedi Cubici	Ampiezza	99 1/4	252	103	261.6	95 7/8	243.5	40 5/8	103.2
2.6 Metri x 1.8 Metri	3.93 Metri Quadrati	6.98 Metri Cubici	Profondità	68 1/4	173.5	72	183	63 1/2	161.2		
			Altezza			79 5/8	204.5	70	177.8	68 1/8	173

Snow carico testato max. 20lbs / Piedi Quadrati (come per IP standard) / 0.5 kN/Metri Quadrati [Test di carico di TUV].  
 “We consigliamo di eliminare la neve dalla tetto del tetto dopo ogni nevicata.”  
 Una profondità di neve di oltre 10 cm può diventare pericolosa!

PL

## Wymiary budowlane:

Przybliżone wymiary	Magazynowa		Wymiary zewnętrzne				Wymiary wewnętrzne		Otwieranie drzwi		
	Powierzchnia	Kubatura	Wymiary fundamentów		Dachu od krawędzi do krawędzi		od ściany do ściany				
			Cal	cm	inch	cm	inch	cm	inch	cm	
8 Stopy x 6 Stopy	42 1/4 Stopy kwadratowy	246 1/2 Stopy sześcienny	<b>Szerokość</b>	99 1/4	252	103	261.6	95 7/8	243.5	40 5/8	103.2
2.6 Metr x 1.8 Metr	3.93 Metr kwadratowy	6.98 Metr sześcienny	<b>Głębokość</b>	68 1/4	173.5	72	183	63 1/2	161.2		
			<b>Wysokość</b>			80 1/2	204.5	70	177.8	68 1/8	173

Obciążenia śniegiem testowałem max.20lbs / Stopy kwadratowy(jak na IP Standard) / 0.5 kN/Metr kwadratowy [Testowane obciążenie TUV].

“Zalecamy wyczyszczenie śniegu z dachu dachu po każdym śniegu.”  
Możliwość śniegu powyżej 10 cm może stać się niebezpieczna!

RO

## Cladirea dimensiuni

Dimensiunea aproximativa	Depozitarea		Dimensiunea exterioara				Dimensiunea interne		deschiderea usii		
	Suprafata	Volumul	Baza dimensiuni		Acoperisul marginea la marginea		perete in perete				
			inch	cm	inch	cm	inch	cm	inch	cm	
8 Picioare x 6Picioare	42 1/4 Picioare pătrați	246 1/2 Picioare cubi	<b>Latimea</b>	99 1/4	252	103	261.6	95 7/8	243.5	40 5/8	103.2
2.6 Metri x 1.8 Metri	3.93 Metri pătrați	6.98 Metri cubi	<b>Adancimea</b>	68 1/4	173.5	72	183	63 1/2	161.2		
			<b>Inaltimea</b>			80 1/2	204.5	70	177.8	68 1/8	173

Rezultatea de încărcare maximă testată. 20lbs / Picioare pătrați (conform standardului IP) / 0.5 kN/Metri pătrați [TUV de sarcină testată].

“Vă recomandăm să eliminați zăpada din partea superioară a acoperișului după fiecare zăpadă.”  
O adâncime de zăpadă mai mare de 10 cm poate deveni periculoasă!

BG

## Сградата измерение

Ориентировачна размер	Съхранение		Външно измерение				Министърът на вътрешните измерение		Вратата отваряне		
	Площ	Обем	База измерение		Покрив край до край		Стената на стената				
			Инча	Сантиметра	Инча	Сантиметра	Инча	Сантиметра	Инча	Сантиметра	
8 Фута x 6 Фута	42 1/4 Квадратни Фута	246 1/2 Кубични Фута	<b>Ширина</b>	99 1/4	252	103	261.6	95 7/8	243.5	40 5/8	103.2
2.6 Метра x 1.8 Метра	3.93 Квадратни Метра	6.98 Кубични Метра	<b>Дълбочина</b>	68 1/4	173.5	72	183	63 1/2	161.2		
			<b>Височина</b>			80 1/2	204.5	70	177.8	68 1/8	173

Тестване на тежестта на снемане макс. 20lbs / Квадратни Фута (според IP Стандарт) / 0.5 kN/Квадратни Метра [Тествано натоварване на TUV].

“След всеки снеговалеж препоръчваме да изчистите снега от покрива на покрива.”  
Дълбочина на снега повече от 10 см може да стане опасна!

TR

## İnşaat boyutu

Tahmini büyüklüğü	Depo		Dış boyutlar				İç boyutu		Kapı açılması		
	Alan	Hacim	Temel boyutundaki		sertliği için harekete		Duvardan duvara				
			İnç	Sanтимetre	İnç	Sanтимetre	İnç	Sanтимetre	İnç	Sanтимetre	
8 Fit x 6 Fit	42 1/4 Metre Fit	246 1/2 Kübik Fit	<b>Genişlik</b>	99 1/4	252	103	261.6	95 7/8	243.5	40 5/8	103.2
2.6 m x 1.8 m	3.93 Metrekare	6.98 Kübik metre	<b>Derinlik</b>	68 1/4	173.5	72	183	63 1/2	161.2		
			<b>Yükseklik</b>			80 1/2	204.5	70	177.8	68 1/8	173

Saat yükü test max. 20lbs / Metre Fit (IP Standardına göre) / 0.5 kN/Metrekare [TUV Yükü test edildi].

“Her Kar yağışı sonrasında Çatı üstten kar temizlemenizi öneririz.”  
Kar derinliği 10 cm'den fazla tehlikeli olabilir!

**EN Tools You Will Need**

- |                                  |                     |
|----------------------------------|---------------------|
| 1. Cordless Drill - Philips Head | 6. Tape Measure     |
| 2. Screwdriver - Philips Head    | 7. Hand Gloves      |
| 3. Carpenters Square             | 8. Eye Protector    |
| 4. 8' Step Ladder                | 9. Box Spanner-7 mm |
| 5. Level - 3ft.                  |                     |

**FR Outils dont vous aurez besoin**

- |                                     |                                |
|-------------------------------------|--------------------------------|
| 1. Perceuse sans fil – Tête Philips | 6. Ruban à mesurer             |
| 2. Tournevis - Tête Philips         | 7. Gants                       |
| 3. Équerre du Menuisier             | 8. Protecteur des Yeux         |
| 4. Escabeau 8'                      | 9. Clé de serrage de boîte-7mm |
| 5. Niveau - 3ft.                    |                                |

**DE Benötigte Werkzeuge**

- |   |                        |
|---|------------------------|
| 1. Akku-Bohrschrauber - Kreuzschlitzbit | 6. Maßband             |
| 2. Kreuzschlitz-Schraubenzieher         | 7. Handschuhe          |
| 3. Winkelmaß                            | 8. Schutzbrille        |
| 4. 8' Leiter                            | 9. Kasten-             |
| 5. Wasserwaage – 1 m                    | Schraubenschlüssel-7mm |

**ES Herramientas necesarias para el montaje**

- |  |                                |
|--|--------------------------------|
| 1. Atornillador eléctrico con cabeza estrella/ Philips | 6. Cinta métrica               |
| 2. Destornillador estrella / Philips                   | 7. Use guantes de seguridad    |
| 3. Gafas protectoras                                   | 8. Escuadra                    |
| 4. Escalera de 8 peldaños                              | 9. Llave de tuerca de caja-7mm |
| 5. Nivel de 1m   |                                |

**PT Ferramentas que irá precisar**

- |                                    |                                   |
|------------------------------------|-----------------------------------|
| 1. Cordless Berbequim              | 6. Fita Métrica                   |
| 2. Chave de fenda – cabeça estrela | 7. Luvas                          |
| 3. Esquadro de carpinteiro         | 8. Protector Ocular               |
| 4. Escadote 8"                     | 9. Chave de parafuso de caixa-7mm |
| 5. 3ft. Nivel                      |                                   |

**NL Gereedschappen die u nodig zult hebben**

- |   |                    |
|---|--------------------|
| 1. Snoerloze boormachine met gekruiste kop      | 6. Meetlint        |
| 2. Snoerloze schroevendraaier met gekruiste kop | 7. Handschoenen    |
| 3. Winkelhaak                                   | 8. Oogbescherming  |
| 4. Ladder met acht treden                       | 9. Vak spanner-7mm |
| 5. Waterpas                                     |                    |

**CS Budete potřebovat toto nářadí**

- |                                 |                          |
|---------------------------------|--------------------------|
| 1. Bezdrátová vrtačka - Philips | 6. Svinovací metr        |
| 2. Vrták - Philips              | 7. Rukavice              |
| 3. Tesařské náměstí             | 8. Ochranné brýle        |
| 4. 8mí stupňový žebřík          | 9. Krabicový klíč - 7 mm |
| 5. Vodováha - 3ft.              |                          |

**SK Nástroje, ktoré budete potrebovať**

- |                                      |                      |
|--------------------------------------|----------------------|
| 1. Bezdrôtová vrtačka - Philips Head | 6. Meter             |
| 2. Šraubovák – Philips Head          | 7. Rukavice          |
| 3. Stolársky meter                   | 8. Ochranu na oči    |
| 4. 8' Rebrík                         | 9. Kľúčový kľúč 7 mm |
| 5. Zdvihák – 3 stopy.                |                      |

**SL Orodje, ki ga boste potrebovali**

- |                                    |                    |
|------------------------------------|--------------------|
| 1. Brezžična vrtalna- glava Philip | 6. Merilni trak    |
| 2. Vijaknik-glava Philip           | 7. Rokavice        |
| 3. Mizarski kvadrat                | 8. zaščitna očala  |
| 4. 2438,4 mm dvokraka lestev       | 9. Polje kjuč-7 mm |
| 5. Nivelirka - 0,91 m              |                    |

**HR Alati, Trebat će Vam**

- |                                      |                              |
|--------------------------------------|------------------------------|
| 1. Bežični Svrđlo – Philips Voditelj | 6. Traka Divizor             |
| 2. Vijak Vozač - Philips Voditelj    | 7. Ručni Rukavice            |
| 3. Drvodjelac Četverokut             | 8. Oko Zaštitnik             |
| 4. 8' Korak Ljestve                  | 9. Kutija za ključeve - 7 mm |
| 5. Razina – 3 stoplo.                |                              |

**HU A szükséges szerszámok**

- |                                       |                  |
|---------------------------------------|------------------|
| 1. Vezeték nélküli fúró – csillagfejű | 6. Mérőszalag    |
| 2. Csavarhúzó – csillagfejű           | 7. Kesztyűk      |
| 3. Ácsderékszög                       | 8. Szemvédő      |
| 4. 8-fokú létra                       | 9. Csőkulcs-7 mm |
| 5. Vízszintmérő.                      |                  |

**SV Verktyg du kommer att behöva**

- |                                      |                        |
|--------------------------------------|------------------------|
| 1. Sladdlös bormaskin - Philips borr | 6. Måttband            |
| 2. Skruvmejsel - krysshuvud          | 7. Verktygshandskar    |
| 3. Vinkelhake                        | 8. Ögonskydd           |
| 4. 8-fots stege                      | 9. Box skiftnyckel-7mm |
| 5. vattenmått - 3fot.                |                        |

**IT Gli Attrezzi di cui Avrai Bisogno**

- |  |                             |
|--|-----------------------------|
| 1. Trapano senza fili – Punta a stella | 6. Metro a Nastro           |
| 2. Cacciavite – Punta a stella         | 7. Guanti                   |
| 3. Squadra metallica                   | 8. Protezione per gli occhi |
| 4. Scala ad 8 pioli                    | 9. Chiave a tubo - 7mm      |
| 5. Livello – 3 piedi                   |                             |

**PL Potrzebne narzędzia**

- |   |                      |
|---|----------------------|
| 1. Bezprzewodowa wkrętarka – krzyżakowa | 6. Taśma miernicza   |
| 2. Śrubokręt krzyżakowy                 | 7. Rękawice ochronne |
| 3. Kałownik stolarski                   | 8. Okulary ochronne  |
| 4. 8' Drabina składana                  | 9. Klucz-Box 7mm     |
| 5. Poziomica – 91,4 cm                  |                      |

**RO Instrumentele de care aveți nevoie**

- |                                     |                          |
|-------------------------------------|--------------------------|
| 1. Șurubelniță – cap Philips        | 6. Ruletă de măsurat     |
| 2. Mașină de găurit – cap Philips   | 7. Mănuși de protecție   |
| 3. Echer de dulgherie               | 8. Protecție pentru ochi |
| 4. Scară cu trepte de 8' (20.32 cm) | 9. Caseta Spanner-7mm    |
| 5. Nivel - 3ft.                     |                          |

**BG Инструменти, които ще ви трябват**

- |   |                        |
|---|------------------------|
| 1. Безжична бормашина - с глава Philips | 6. Рулетка             |
| 2. Отвертка – с глава Philips           | 7. Ръкавици            |
| 3. Прав ъгъл                            | 8. Маска за очите      |
| 4. Стълба – 20 см (8')                  | 9. Гаечная коробка-7mm |
| 5. Нивелир – 1 м (3ft).                 |                        |

**TR İhtiyaç duyacağınız aletler**

- |                                    |                        |
|------------------------------------|------------------------|
| 1. Kablosuz Matkap- Philips Başlık | 6. Mezura              |
| 2. Tornavida-Philips Başlık        | 7. Eldiven             |
| 3. Marangoz gönyesi                | 8. Göz Koruyucu        |
| 4. 8 Basamaklı Merdiven            | 9. Geçme Anahtar – 7mm |
| 5. Seviye- 91,5 cm.                |                        |

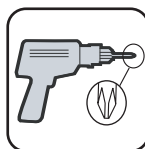

1

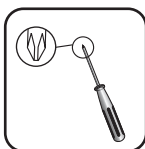

2



3

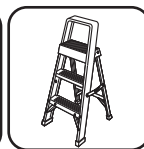

4

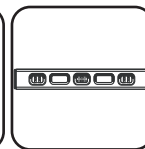

5

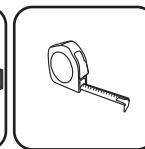

6

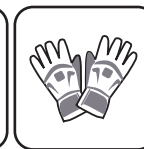

7

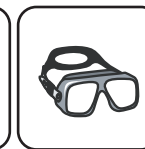

8

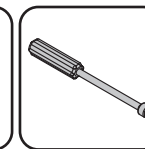

9

**EN** Parts List

**FR** Liste des pièces

**DE** Teileliste

**ES** Listado de piezas

**PT** Lista de Peças

**NL** Onderdelenlijst

**CS** Seznam součástí

**SK** Zoznam častí

**SL** Seznam delov

**HR** Dijelovi Lists

**HU** Alkatrésztlista

**SV** Komponentlista

**IT** Lista delle varie parti

**PL** Lista części

**RO** Lista elementelor componente

**BG** Списък на частите

**TR** Parça Listesi

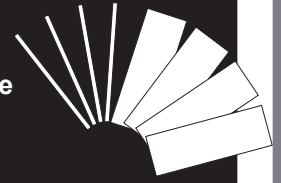

- EN** 1. Check all parts prior to installation.  
2. Use screws with plastic washers on top of prepainted surface only.  
3. Before starting installation, please refer Safety & Precautions.

- FR** 1. Vérifier toutes les pièces avant l'installation.  
2. Utilisez des vis avec des rondelles en plastique sur le dessus de la surface pré peinte seulement.  
3. Avant de commencer l'installation, référez-vous svp à Sécurité et Précautions.

- DE** 1. Prüfen Sie alle Teile vor der Montage.  
2. Benutzen Sie bei lackierten Oberflächen nur Schrauben mit Plastikunterlegscheiben.  
3. Lesen Sie vor dem Aufbau die Sicherheitsanweisungen.

- ES** 1. Verifique todo el despiece antes del montaje.  
2. Use los tornillos y las arandelas plásticas solo en las partes prepintadas.  
3. Antes de comenzar el montaje, consulte el apartado de seguridad y precauciones.

- PT** 1. Confirme todas as peças antes da instalação.  
2. Utilize parafusos com anilhas plásticas em cima da superfície prepainted apenas.  
3. Antes de iniciar a instalação, cheque item "Segurança e Cuidados".

- NL** 1. Controleer vooraf of alle onderdelen aanwezig zijn.  
2. Gebruik schroeven met plasticen ring aan de bovenkant of voor gelakt ondergrond.  
3. Voordat u begint met installeren, verwijzing naar veiligheid voorschriften.

- CS** 1. Něž začnete s montáží, zkontrolujte všechny součásti.  
2. Používejte šrouby z plastovým těsněním pouze na natřené plochu.  
3. Před montáží si prosím přečtěte Bezpečnost a bezpečnostní opatření.

- SK** 1. Skontrolujte všetky časti pred inštaláciou.  
2. Použite skrutky s plastovými podložkami len na natretej ploche.  
3. Skôr ako začnete s inštaláciou, prečítajte si Bezpečnosť a bezpečnostné opatrenia.

- SL** 1. Pred montažo preverite vse dele.  
2. Uporabite vijake s plastičnimi podložkami samo na vrhu grundirane površine.  
3. Pred začetkom namestitve, glejte VARNOST & VARNOSTNI UKREPI.

- HR** 1. Provjera svih dijelova prije instalacije.  
2. Koristite vijaka sa plastičnim podmetakima na vrhu od unaprijed obojana površina.  
3. Prije nego Vi počnete instalacija, molim vas pogledajte Sigurnost i mjere opreza

- HU** 1. Ellenőrizzen minden alkatrészt az összeszerelés megkezdése előtt.  
2. Előre festett felületeken csak műanyag alátétekkel használja a csavarokat.  
3. Az összeszerelés megkezdése előtt kérjük vegye figyelembe a biztonsági utasításokat.

- SV** 1. Kolla alla delar före installationen.  
2. Använd skruvar med plastbrickor bara på målade ytor.  
3. innan man startar installationen ska man läsa igenom säkerhet & försiktighetsåtgärder.

- IT** 1. Controlla tutte le parti prima dell'installazione.  
2. Usa viti con rondelle di plastica sulla parte superiore delle superfici preverniciate.  
3. Prima di incominciare con l'installazione, per favore leggi attentamente I punti illustrati nel paragrafo Sicurezza ed Installazione.

- PL** 1. Sprawdź wszystkie części zanim przystąpisz do montażu.  
2. Używaj śrub z plastikowymi uszczelkami wyłącznie na wcześniej pomalowanej powierzchni.  
3. Przed rozpoczęciem instalacji należy przeczytać rozdział Bezpieczeństwo i środki ostrożności.

- RO** 1. Verificați toate părțile componente înainte de instalare.  
2. Folosiți șuruburi cu șaibe de plastic doar pe suprafața prevopsită.  
3. Înainte de a începe asamblarea, consultați capitolul. Măsuri de siguranță și protecție.

- BG** 1. Проверете всички части преди монтажа.  
2. Използвайте винтове с пластмасови шайби само върху предварително боядисани повърхности.  
3. Преди започване на монтажа, моля разгледайте Безопасност и Защита.

- TR** 1. Kurulumdan önce tüm parçaları kontrol ediniz.  
2. Önceden boyanmış yüzey için sadece Vida ve plastik pul kullanınız.  
3. Montaja başlamadan önce lütfen Güvenlik ve Önlemler kısmına bakınız.



	MB01	1
	MB02	1
	MB03	2
	MA05	2
	MB04	1
	MA07	4
	ME01	1
	ME02	1
	MB05	1
	MB06	1
	MA12	1
	MB10	1
	MB07	1
	MB08	1
	MF10	2
	MF11	2
	MB17	2
	MB18	2
	MF01	2
	ME05	2
	MF02	2
	MF03	1
	MF04	1
	ME10	1
	ME11	2
	ME12	1
	ME13	1
	MF06	3
	MF07	1
	MA18	2
	MF05	2
	MF08	2
	MF09	2
	MF12	2
	MB20	1
	MB21	1

	MB22	1
	MB23	1
	MA32	2
	ME25	2
	ME26	2
	ME28	6
	ME27	4
	MF13	2
	MF14	2
	MF15	2
	MF16	2
	MF17	2
	MF18	1
	MF19	1

	TC	4
	MA47	4
	MA48	8
	MA49	2
	PW	3Slab
	PC	5Slab
	WST	2.8 Mtr
	F1	22
	S1	288
	S2	38
	S8	22
	S3	54



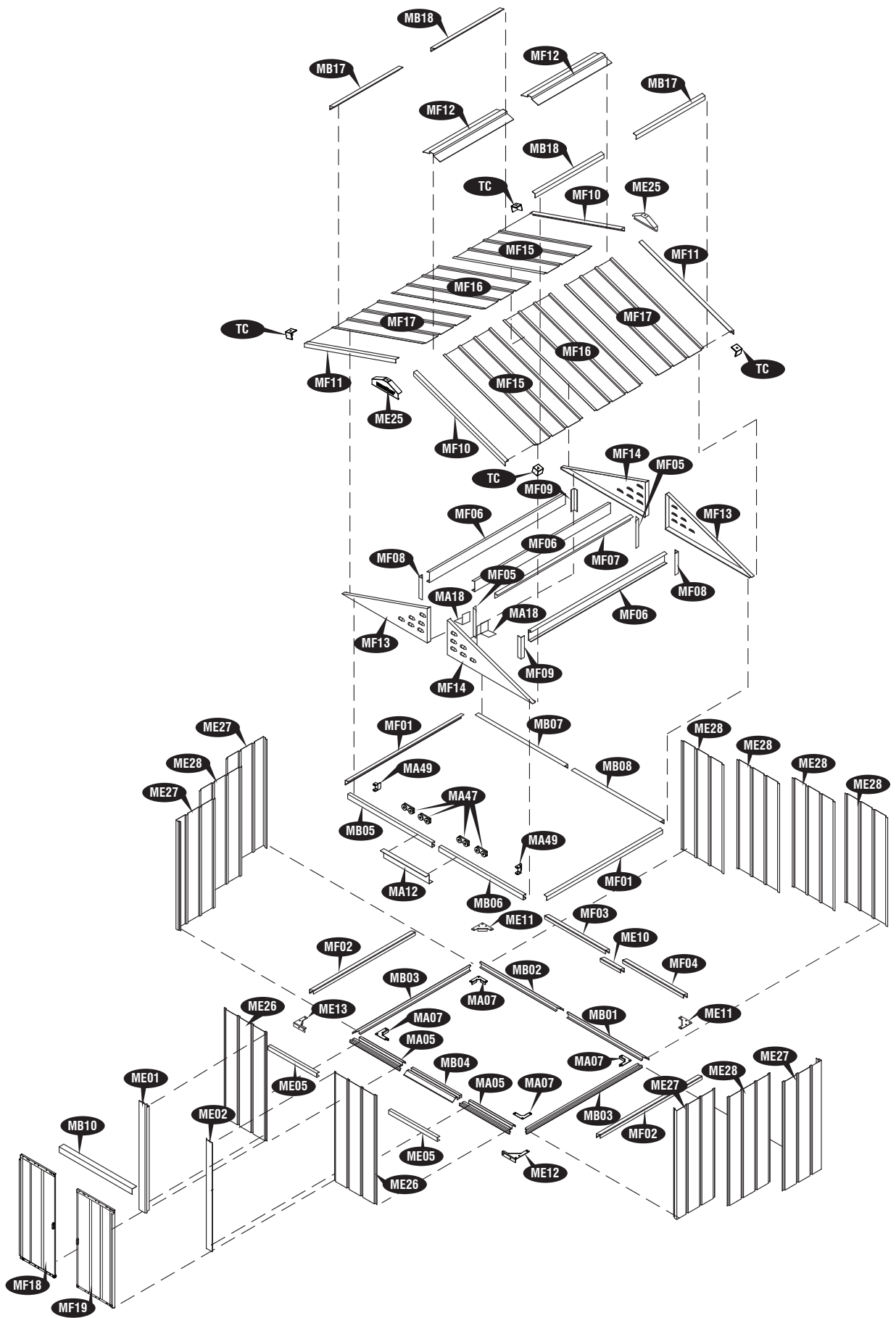

- 1** → #16-18
- 2** → # 19-35
- 3** → # 36-49
- 4** → # 52-56

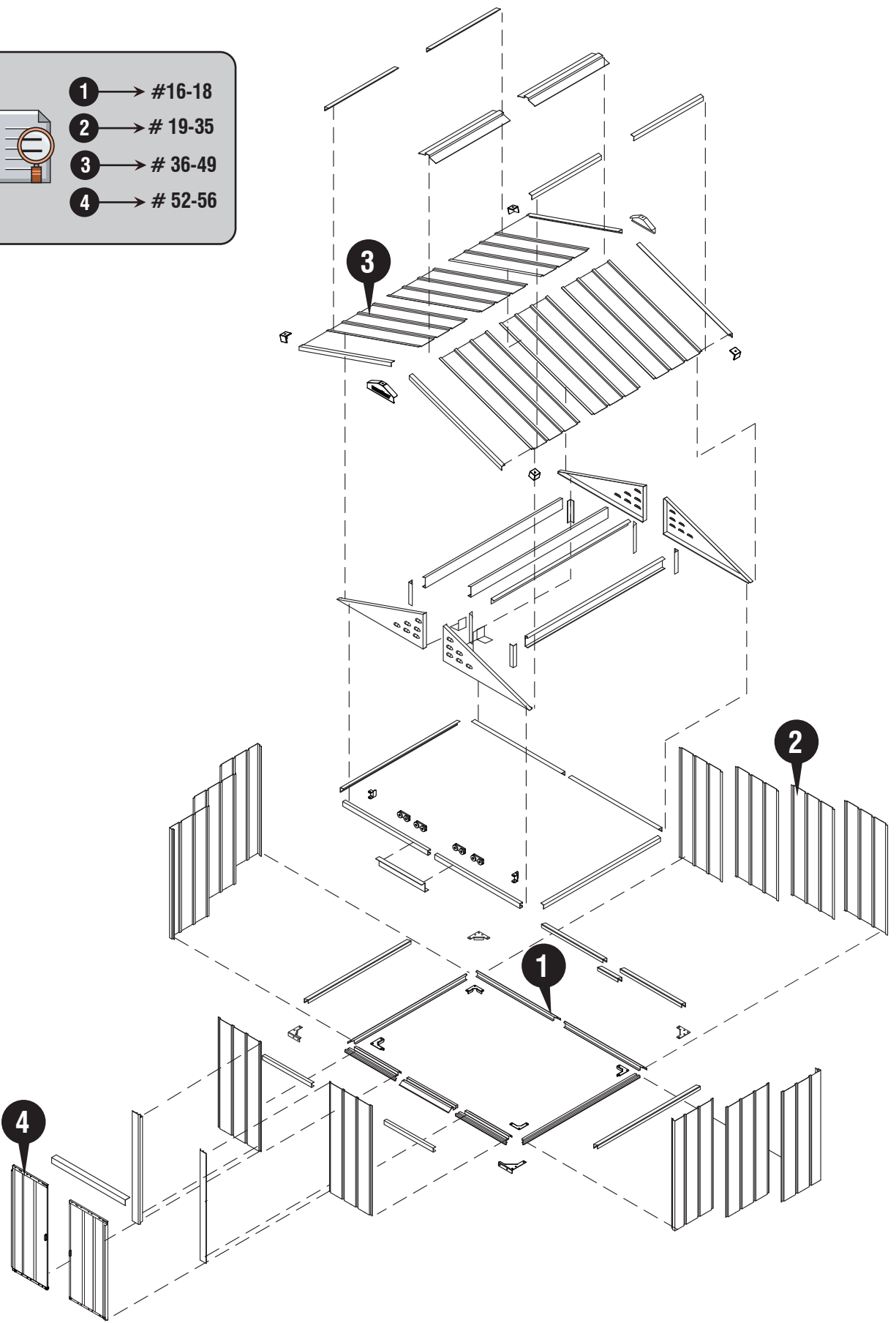



EN	Foundation	CS	Základy	IT	Fondamenta
FR	Fondation	SK	Základ	PL	Podstawa
DE	Fundament	SL	Temelj	RO	Fundația
ES	La cimentación	HR	Temelj	BG	Фундамент
PT	Fundação	HU	Alap	TR	Temel
NL	Fundering	SV	Grunden		

- (EN) DuraMax must be installed on a DuraMax Foundation, level wooden platform or a level concrete foundation.  
(FR) Duramax doit être installé sur une fondation Duramax, une plate-forme en bois de niveau ou une fondation en béton de niveau  
(DE) Duramax muss auf einem Duramax Fundament, einer ebenen Holzplattform oder einem ebenen Betonfundament installiert werden  
(ES) Su caseta debe estar firmemente anclada a la base de hormigón o bien sujeta con piedras de base cuadrada para proteger que se pueda volar con el viento.  
(PT) Duramax deve ser instalado em uma base Duramax, plataforma de madeira de nível ou uma base de concreto nivelada.  
(NL) Duramax moet geïnstalleerd worden op een Duramax foundation, level houten platform of een betonconcentratie.  
(CS) Duramax musí být instalován na základně Duramax, dřevěnou plošinu nebo rovinnou základovou konstrukcí.  
(SK) Firma Duramax musí byť inštalovaná na základni Duramax, na drevenej plošine alebo na úrovni betónu.  
(SL) Duramax mora biti nameščen na temelju Duramax, ravne lesene ploščadi ali ravne betonske podlage  
(HR) Duramax mora biti instaliran na temeljima Duramax, drvenoj platformi ili razini konkretnog betona.  
(HU) A Duramax-ot Duramax alapra, szintetikus fapadlóra vagy szintetikus betonra kell telepíteni.  
(SV) Duramax måste installeras på en Duramax-grund, en plan träplattform eller en jämn betongfundament.  
(IT) Duramax deve essere installato su una base Duramax, una piattaforma di legno a livello o una base di calcestruzzo a livello.  
(PL) Duramax musi być zainstalowany na fundamencie Duramax, poziomą platformę drewnianą lub poziomą podbudowę betonu.  
(RO) Duramax trebuie instalat pe o fundație Duramax, platformă de lemn de nivel sau fundație de beton.  
(BG) Duramax трябва да се монтира на основата на Duramax, дървена платформа на нивото или на бетонна основа.  
(TR) Duramax, bir Duramax vakfı, düz ahşap platform veya düz bir beton temel üzerine kurulmalıdır.



- (EN) If you have DURAMAX Foundation, please follow instruction manual in that package. If not, follow the below OPTION1 or OPTION 2.  
(FR) Si vous avez DURAMAX Foundation, veuillez suivre manuel dans ce paquet. Si non, suivez le ci-dessous OPTION 1 ou OPTION 2.  
(DE) Duramax muss auf einem Duramax Stiftung oder ein Niveau hölzernen Plattform oder einem Niveau Betonfundament montiert werden.  
(ES) Duramax debe estar instalado en una base Duramax o una plataforma de madera de nivel o una base de hormigón nivelada.  
(PT) Duramax deve ser instalado sobre uma base Duramax ou uma plataforma de madeira nível ou uma fundação de concreto nível.  
(NL) Duramax moet op een Duramax stichting of een vlakke houten platform of een vlakke betonnen fundering worden geïnstalleerd.  
(CS) Pokud máte DURAMAX Foundation, postupujte podle pokynů v tomto balení. Pokud ne, postupujte podle níže uvedených možností OPTION 1 nebo OPTION 2  
(SK) Ak máte DURAMAX Foundation, postupujte podľa pokynov v tomto balíku. Ak nie, postupujte podľa nižšie uvedených možností OPTION 1 alebo OPTION 2.  
(SL) Če imate DURAMAX Foundation, sledite navodilom v tem paketu. Če ne, sledite spodnjemu OPCIJI 1 ali MOŽNOSTI 2.  
(HR) Ako imate DURAMAX Foundation, slijedite upute za uporabu u tom paketu. Ako ne, slijedite dolje OPTION 1 ili OPTION 2.  
(HU) Ha rendelkezik DURAMAX Alapítványsal, kérjük, kövesse az adott csomagban található használati utasítást. Ha nem, kövesse az alábbi OPTION 1 vagy OPTION 2 opciókat.  
(SV) Om du har DURAMAX Foundation, följ instruktionsboken i det paketet. Om inte, följ följande alternativ 1 eller alternativ 2.  
(IT) Se hai la DURAMAX Foundation, segua il manuale di istruzioni in quel pacchetto. In caso contrario, segui la seguente OPZIONE 1 o OPZIONE 2.  
(PL) Jeśli masz DURAMAX Fundacji, postępuj zgodnie z instrukcją obsługi w tym pakiecie. Jeśli nie, wykonaj poniżej opcję 1 lub 2 opcję.  
(RO) Dacă aveți Fundația DURAMAX, vă rugăm să urmați manualul de instrucțiuni din acel pachet. Dacă nu, urmați OPȚIUNEA 1 sau OPȚIUNEA 2 de mai jos.  
(BG) Ако имате DURAMAX Foundation, моля, следвайте инструкциите за употреба в тази опаковка. Ако не, следвайте OPTION 1 или OPTION 2.  
(TR) DURAMAX Vakfı'na sahipseniz, lütfen bu pakette yer alan kullanım kılavuzunu izleyin. Değilse, aşağıdaki OPTION 1 veya OPTION 2'yi izleyin.

EN Wooden Platform (Not Included)

CS Dřevěný základ (není součástí)

IT Piattaforma di legno (non incluso)

FR Plate-forme en bois (non incluse)

SK Drevený podklad (Nedodáva sa)

PL Platforma drewniana (nie objęte)

1

DE Holzplattform (nicht im Lieferumfang)

SL Leseni pod (ni priložen)

RO Platformă de lemn (Nu este inclusă)

ES Plataforma de madera (no incluida)

HR Drveni platform (Nije Uključena)

BG Дървена платформа (Не е включена)

PT Plataforma de madeira (Não incluida)

HU Fa emelvény (Nem szerepel a csomagban)

TR Tahta Platform (Pakete dahil değildir)

NL Houten platform (niet inbegrepen)

SV Träplattform (inte inkluderad)



1

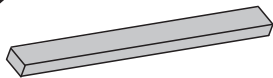

70"x 3 1/2" X 2" (x3)

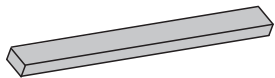

91 1/2" x 3 1/2" X 2" (x4)

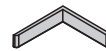

(x4)

(EN) Lay 2 x 4 Flat Pressure Treated Weather proof Wood Studs:  
(Actual size 2"x 3 1/2", 50mm x 88.9mm)

(FR) Aire Plate 2" x 4" Pression de l'épreuve des intempéries  
traités goujons de bois:  
(Taille réelle 2" x 3 1/2", 50mm x 88.9mm)

(DE) 2 x 4 Latten flachlegen Druck behandelt wetterfestes Holz-Stollen  
(Aktuelle Größe 2" x 3 1/2", 50 x 88.9)

(ES) Coloque los listones perimetrales sobre los que echar la solera. Estos  
deben ser tratados para evitar que se expandan con el agua. Medidas de  
los mismo 50mm x 88,9mm

(PT) Deitare 2" x 4"mm Plano Pressão à prova de intempéries tratados  
parafusos prisioneiros de madeira:  
(tamanho atual 2" x 3 1/2", 50mm x 88.9mm)

(NL) Laag 2 x 4 Vlak Druk behandeld weer bewijs hout hengsten  
(Precieze maat 2 x 3 1/2, 50 mm x 88.9 mm)

(CS) Položte 2 x 4 plohy tlak ošetřené počasí proof dřevo hřeby.  
(Skutečné velikosti 2" x 3 1/2", 50 x 88.9)

(SK) Plocha 2 x 4 tlak ošetřené počasie dôkaz drevené gombíky.  
(Skutočné veľkosti 2" x 3 1/2", 50 x 88.9)

(SL) Položite ravno 2 x 4 pritisk obravnavačo vreme dokaz lesa klinov  
(Dejanska velikost 2" x 3 1/2", 50 x 88.9)

(HR) Stavite 2 x 4 ravno Pressure Obradeni vremenski dokazni drveni klin.  
(Stvarnoj veličini 2" x 3 1/2", 50 x 88.9)

(HU) 2 x 4 sima nyomás kezelt időjárás bizonyítékot szegekkel fa  
(Tényleges méret 2" x 3 1/2", 50 x 88.9)

(SV) Lågg 2 x 4 platt Tryck behandlat väder bevis trä dubbar.  
(Verklig storlek 2" x 3 1/2", 50mm x 88.9mm)

(IT) Laici 2 x 4 pressione trattati Meteo prova.  
(Dimensione attuale 2" x 3 1/2", 50 mm x 88.9 mm)

(PL) Połóż płasko słupki 2x4 Ciśnienia traktowane  
pogodowodó drewna stadniny  
(Rzeczywisty rozmiar 2" x 3 1/2", 50mm x 88,9mm)

(RO) Așezați plăcile 2 x 4 pe o suprafață plană  
Pressure tratate de intemperii Wood Studs  
(Dimensiunea reală 2" x 3 1/2", 50 x 88.9)

(BG) Поставете плоскост с размери 2 x 4 Pressure  
Третирани Противотехнически дървесни щифтове.  
(Застроена 2" x 3 1/2", 50 x 88.9)

(TR) 2 x 4 ölçüsünde zemin Pressure Tedavi Hava  
geçirmez Ahşap Studs.  
(2" x 3 1/2", 50 x 88.9 Gerçek boyut)

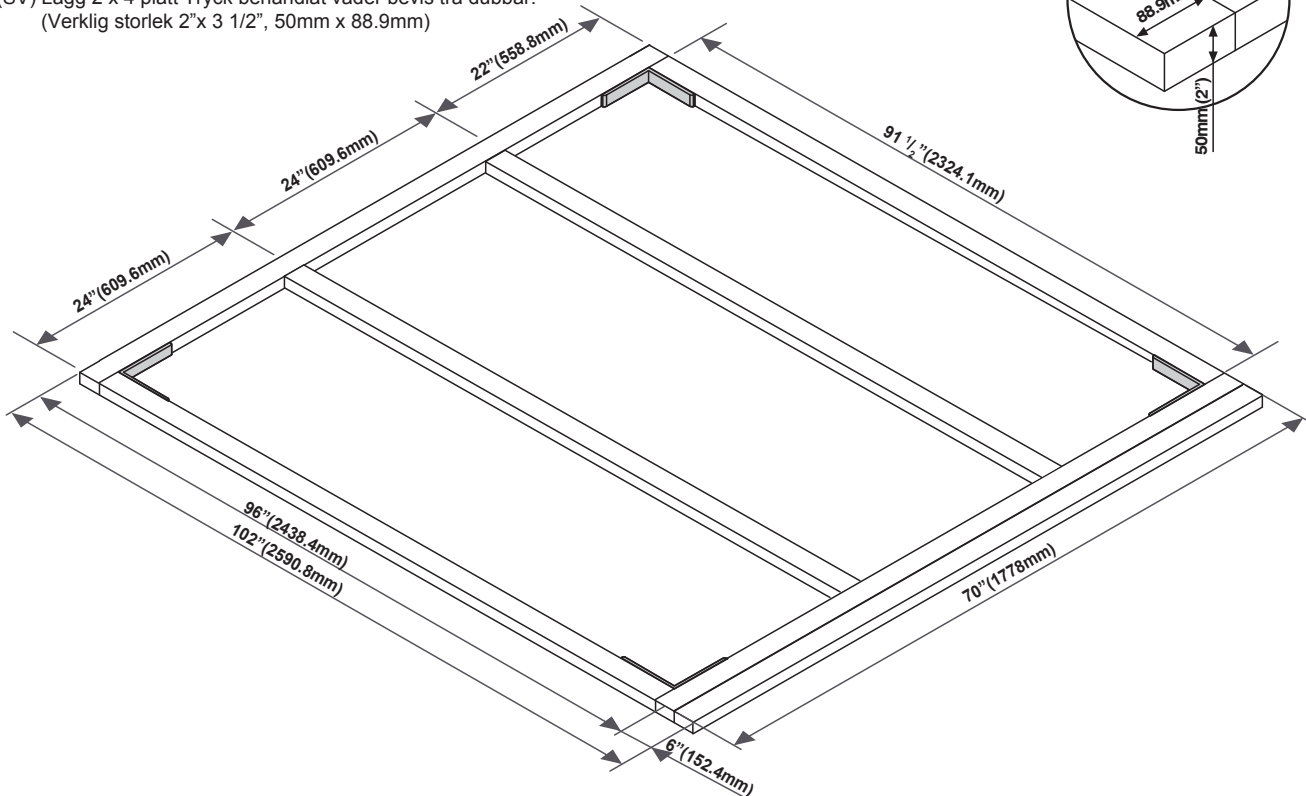
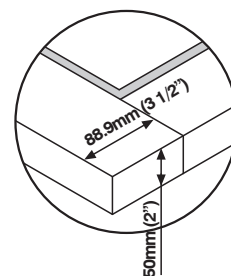

2

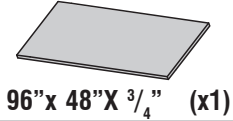

96"x 48"x 3/4" (x1)

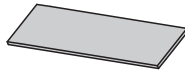

96"x 22"x 3/4" (x1)



6"x 70"x 3/4" (x1)

**(EN) Exterior Grade (CDX) - 3/4" (19mm) Weather proof Marine grade plywood**

(FR) Qualité extérieure (CDX) - 3/4 po (19mm) météo preuve Marine grade contreplaqué..

**(DE) Aussenansicht Grade (CDX) - 3/4" (19mm) Wetter Beweis Marine Grade Sperrholz.**

(ES) Calidad exterior (CDX) - 3/4" (19mm) de madera contrachapada y resistente al agua.

**(PT) Grade exterior (CDX) - 3/4" (19mm) tempo prova da classe madeira compensada marinha.**

(NL) Exterieur Grade (CDX) - 3/4" (19mm) weer bewijs Marine grade multiplex.

**(CS) vnější Grade (CDX) - 3/4" (19mm) počasí důkaz Marine překližované desky.**

(SK) exteriéru Grade (CDX) - 3/4" (19mm) počasie dôkaz Marine preglejku.

**(SL) zunanost razred (CDX) - 3/4" (19mm) vreme dokaz Marine Les**

(HR) Exterior Grade (CDX) - 3/4" (19mm) Mjerno vrijeme morskara razreda šperploča..

**(HU) külső fokozat (CDX) - 3/4" (19mm) Időjárás bizonyítékot tengeri minőségű rétegelt lemezt.**

(SV) exteriör Grade (CDX) - 3/4" (19mm) väder bevis Marine grade plywood.

**(IT) borchie di legno esterna Grade (CDX) - 3/4" (19mm) compensato Meteo prova Marine**

(PL) Zewnętrzny stopień (CDX) - 3/4" (19mm) pogoda dowód Marine sklejkę :

**(RO) Exterior Grad (CDX) - 3/4" (19mm) Rezistență la intemperii placaj de calitate marină.**

(BG) Exterior Grade (CDX) - 3/4" (19mm) Противотемпературен шперплат.

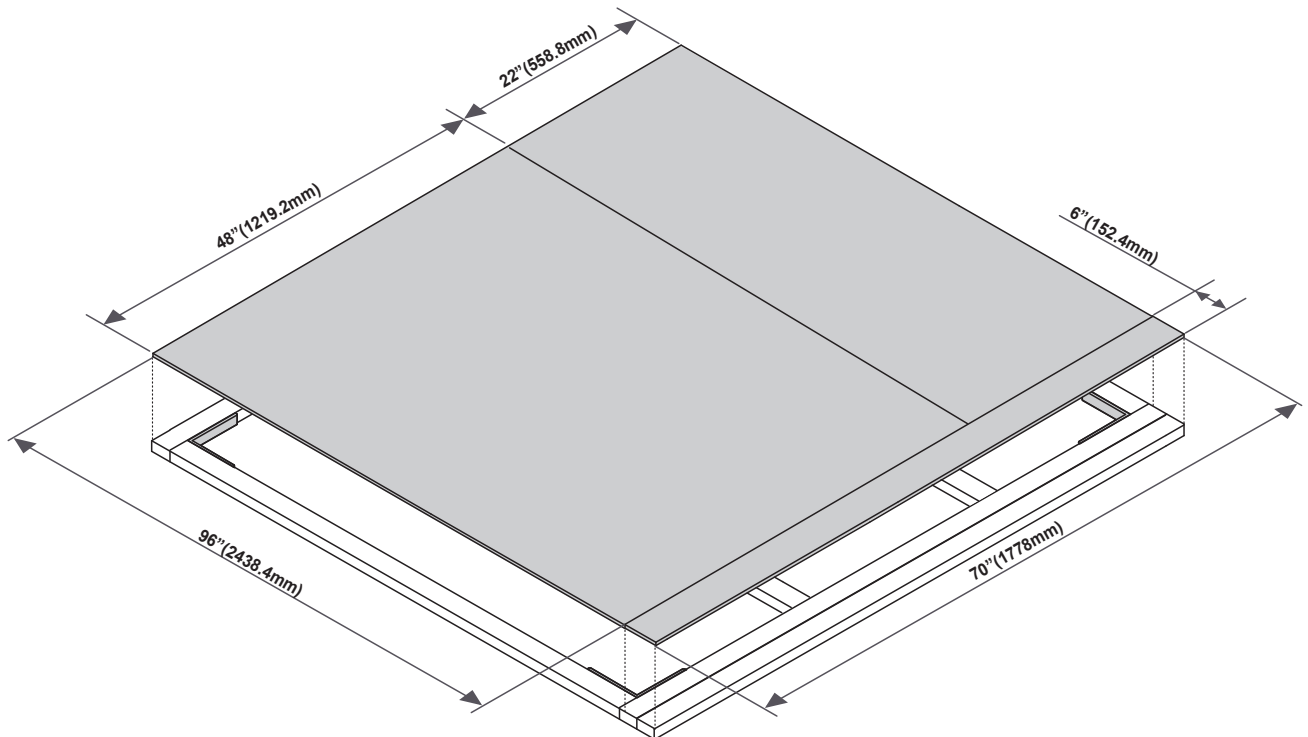
**(TR) Exterior Grade (CDX) - 3/4" (19mm) Hava geçirmez Deniz sınıfı kontrplak**

2

EN Concrete Platform

FR Plate-forme en béton armé

DE Betonauflage plattform

ES Base de hormigón

PT Plataforma concreta

NL Betonnen plaat

CS Betonové Platforma

SK Betónové Platforma

SL Betonski Platform

HR Betonski Platform

HU Beton Platform

SV Betongplattform

IT Piattaforma in cemento

PL Platforma betonowa

RO Platforma de beton

BG Бетон Платформа

TR Beton Platform



- EN** To ensure that your shed withstands high winds, we recommended to use this floor option. A concrete pad or a large size concrete patio stone squares is recommended for suitable floor base. Make sure it is firm and level and will allow drainage away from the site. Make a level concrete foundation, that has an outside dimension of 103 3/8" x 72 1/4" (2620mm x 1835mm). For a concrete pad base, prepare a level bed for a firm footing layer of crushed stone. The concrete pad should then be poured to a thickness of 4 inches (100mm) to 5 inches (125mm). Allow to dry thoroughly for at least 48 hours. Manufacturer is not responsible for the choice and construction of the foundation.
- FR** Pour vous assurer que votre hangar résiste à des vents violents, nous avons recommandé d'utiliser cette option de plancher. Une dalle de béton ou une grande taille concrètes dalles de patio de est recommandé pour base appropriée au sol. Assurez-vous qu'il est ferme et niveau et permettre un bon drainage du site. Faire niveau fondation en béton, qui a une dimension extérieure de 103 3/8" x 72 1/4" (2620mm x 1835mm) Pour hangar de base. Pour une dalle en béton, préparer une couche de graviers de nive au. La dalle doit faire entre 10 et 12.5 cm. Le tampon de béton doit ensuite être coulé sur une épaisseur de 4 pouces (100 mm) à 5 pouces (125 mm). Laisser sécher complètement pendant au moins 48 heures. Le fabricant n'est pas responsable du choix et de la construction des fondations.
- DE** Um sicherzustellen, dass Ihr Schuppen hohen Winden standhält, empfiehlt es sich, diese Bodenoption zu benutzen. Eine konkrete Auflage oder eine große Größe konkreten Patio Stein Quadrate wird empfohlen für die geeignete Standing. Stellen Sie sicher, es ist fest und Ebene und Entwässerung von der Website ermöglicht. Machen Sie eine Ebene Betonfundament, die eine externe Dimension von 103 3/8" x 72 1/4" (2620mm x 1835mm) für eine konkrete Auflage hat base, einer soliden Basis Schicht aus Schotter ein Niveau Bett vorzubereiten. Die konkrete Auflage sollte dann zu einer Dicke von 4 Zoll (100 mm) bis 5 Zoll (125 mm) gegossen werden. Gründlich mindestens 48 Stunden trocknen lassen. Hersteller ist nicht verantwortlich für die Auswahl und Konstruktion der Stiftung.
- ES** Para asegurarse que su caseta resiste vientos fuertes le recomendamos usar esta opción de suelo. Tener una buena base de hormigón le dará más fuerza a la caseta. Asegúrese de colocar en un terreno perfectamente nivelado y que permita un correcto drenaje. Haga una base con un perímetro exterior con las siguientes medidas: 103 3/8" x 72 1/4" (2620mm x 1835mm). Cree el perímetro y coloque piedra para hormigonar en su interior, y eche el hormigón hasta una altura de entre 100mm y 125mm. Déjelo secar al menos 48 horas. El fabricante no es responsable de la construcción de la base de hormigón.
- PT** Para garantir que o seu galpão resiste a ventos fortes, recomendamos usar esta opção de andar. Um bloco de concreto ou um quadrados de pedra de pátio de concreto de tamanho grande é recomendado para base apropriado do assoalho. Certifique-se que é firme e nivelada e permitirá drenagem longe do local. Fazer base de uma fundação de concreto nivel, que tem uma dimensão exterior de 103 3/8" x 72 1/4" (2620mm x 1835mm). Em um bloco de concreto, preparar uma cama de nível para uma camada firme de brita. O base de concreto deve ser derramado em seguida a uma espessura de 4 polegadas (100mm), 5 polegadas (125mm). Deixe para secar completamente pelo menos 48 horas. Fabricante não é responsável pela escolha e construção da Fundação.
- NL** Om ervoor te zorgen dat uw schuur bestand is tegen hoge winden, raden wij u aan deze vloeroptie te gebruiken. Een concrete pad of een groot formaat concrete patio stenen pleinen wordt aanbevolen voor geschikt woord basis. Zorg ervoor dat het is stevig en niveau en drainage zal bestaan weg van de site. Een niveau concrete stichting, die een externe dimensie van 103 3/8" x 72 1/4" (2620mm x 1835mm). For a concrete pad base, prepare a level bed for a firm footing layer of crushed stone. The concrete pad should then be poured to a thickness of 4 inches (100mm) to 5 inches (125mm). Allow to dry thoroughly for at least 48 hours. Manufacturer is not responsible for the choice and construction of the foundation.
- CS** Abyste zajistili, že váš haly odolává silnému větru, doporučujeme použít tuto podlahu. Pro vhodnou podlahovou základnu se doporučuje betonová podložka nebo velké betonové terasové čtverce. Ujistěte se, že je pevný a rovný a umožní odvodnění od místa. Vytvořte hladký betonový podklad, který má vnější rozměr 103 3/8" x 72 1/4" (2620mm x 1835mm) pro základní shed. U betonové podložky připravte rovnou lůžko pro pevnou podkladovou vrstvu drčeného kamene. Betonová vložka by měla být nalita do tloušťky od 100 palců do 5 palců (125 milimetrů). Nechte důkladně vyschnout po dobu nejméně 48 hodin. Výrobce nezodpovídá za volbu a výstavbu nadace.
- SK** Aby ste zabezpečili, že vaša haly odolá vysokému vetru, odporúčame použiť túto podlahovú možnosť. Na vhodnú podlahovú základňu sa odporúča betónová podložka alebo veľké betónové terasové kamenné štvorce. Uistite sa, že je pevný a rovný a umožní odvodnenie z miesta. Vytvorte základový betónový základ, ktorý má vonkajší rozmer 103 3/8" x 72 1/4" (2620mm x 1835mm) pre základňu. Pre betónové podložky pripravte rovno posteljo za trdno podlagu iz drobljenega kamna. Betónová podložka by mala byť potom naliatá do hrúbky 4 palce (100 mm) až 5 palcov (125 mm). Nechajte dôkladne vysušiť aspoň 48 hodín. Výrobca nie je zodpovedný za výber a výstavbu nadácie.
- SL** Da bi zagotovili, da bo vaša hiša odtegnila visoke vetrove, smo priporočili, da uporabite to možnost. Za primerne talne podlage je priporočljiva betonska podloga ali betonski trgi z velikimi površinami. Prepričajte se, da je čvrsta in raven ter omogočila drenažo stran od mesta. Izdelajte ravno betonsko podlogo, ki ima zunanjo dimenzijo dimenzij 103 3/8" x 72 1/4" (2620mm x 1835mm) za Basic Shed. Za betonsko podlogo pripravite ravno posteljo za trdno podlagu iz drobljenega kamna. Betonsko ploščo je treba nato vliti do debeline 4 palcev (100 mm) do 5 palcev (125 mm). Pustite, da se temeljito posuši najmanj 48 ur. Proizvajalec ni odgovoren za izbiro in gradnjo temeljev.
- HR** Da bismo osigurali da vaš prolaz izdrži jak vjetar, preporučujemo da upotrijebite tu podu. Za pogodnu podnu bazu preporučuje se betonska podloga ili velike kamene ploče od betona. Pobrinete se da je čvrsta i razina i omogućit će odvod daleko od stranice. Izradite temeljni betonski temelj koji ima vanjsku dimenziju od 103 3/8" x 72 1/4" (2620mm x 1835mm) za Basic Shed. Za betonsku podlogu, pripremite krevet na razini za čvrsto podnožje slomljenog kamena. Betonsku podlogu treba zatim izliti na debljinu od 100 mm do 125 inča. Ostavite temeljito suhom najmanje 48 sati. Proizvođač nije odgovoran za odabir i izgradnju zaklade.



**HU** Annak érdekében, hogy a fészker ellenálljon a magas szeleknek, javasoljuk, hogy használja ezt a padlót. Betonpárna vagy nagyméretű betonpadló kőpadok ajánlottak megfelelő padlóalakra. Győződjön meg arról, hogy szilárd és vízszintes, és lehetővé teszi a vízvezetést távol a helyszíntől. Végezzünk el egy szintetikus alapot, amely 103 3/8" x 72 1/4" (2620mm x 1835mm) külső méretekkel rendelkezik a Basic Shed számára. **Betonpárnás aljzat esetén készítsen egy szintes ágyat egy szilárd alapozórétre. A betonpárnát ezután 100 mm-es és 125 mm-es vastagságúra kell önteni. Legalább 48 órán keresztül hagyja alaposan száradni. A gyártó nem vállal felelősséget az alapítvány kiválasztásához és megépítéséért.**

**SV** För att säkerställa att din skjul tål hög vind rekommenderar vi att du använder det här golvalternativet. En betongkudde eller en stor betongplattform stenplattor rekommenderas för lämplig golvyta. Se till att den är fast och jämn och gör det möjligt att dränera bort från platsen. Gör en jämn betongfundament, som har en yttre dimension av 103 3/8" x 72 1/4" (2620mm x 1835mm) för Basic Shed. **För en betongplatta bas, förbereda en nivå säng för ett fast fotskikt av krossad sten. Betongplattan ska sedan hållas till en tjocklek av 4 tum (100 mm) till 5 tum (125 mm). Låt torka noggrant i minst 48 timmar. Tillverkaren ansvarar inte för valet och bygandet av stiftelsen.**

**IT** Per garantire che il tuo capannone sopporta venti elevati, abbiamo consigliato di utilizzare questa opzione a pavimento. Si consiglia un tappetino in calcestruzzo o un quadrato in pietra di cemento in grande formato per una base adatta. Assicurarsi che sia stabile e livellato e permetterebbe di drenare lontano dal sito. Realizzare una base di calcestruzzo di livello, che ha una dimensione esterna di 103 3/8" x 72 1/4" (2620mm x 1835mm) per Basic Shed. **Per una base di rilievo in calcestruzzo, preparare un letto a livello per un solido strato di pietra schiacciata. Il tappetino di calcestruzzo deve quindi essere versato ad uno spessore da 100 mm a 125 centimetri. Lasciare asciugare accuratamente per almeno 48 ore. Il produttore non è responsabile della scelta e della costruzione della fondazione.**

**PL** W celu zapewnienia, że szopy wytrzymują wysokie wiatry, zalecamy skorzystanie z tej opcji podłogi. Betonu pad lub duży rozmiar konkretne patio kamień kwadratów jest zalecane dla odpowiedniej bazy piętro. Upewnij się, że to jest prosto i stabilnie i pozwoli drenaż wiatryny. Zrobić fundamentie betonowym poziom, który ma wymiar zewnętrzny 103 3/8" x 72 1/4" (2620mm x 1835mm) **Do betonu pad podstawy, przygotować łóżko poziom dla firmy stopie warstwę tłucznia. Betonu pad powinien być następnie przelewa się do grubości 4 cali (100mm) do 5 cali (125mm). Pozostawić do wyschnięcia dokładnie na co najmniej 48 godzin. Producent nie jest odpowiedzialny za wybór i budowie fundamentów.**

**RO** Pentru a vă asigura că vaporul dvs. rezistă unor vânturi puternice, am recomandat să folosiți această opțiune pentru podea. Un tampon de beton sau o pătrată de piatră din beton de dimensiuni mari este recomandată pentru o bază adecvată pentru podea. Asigurați-vă că este ferm și la nivel și va permite scurgerea departe de site. Asigurați o fundație de beton de nivel, care are o dimensiune exterioară de 103 3/8" x 72 1/4" (2620mm x 1835mm) pentru Shed Basic. **Pentru o bază de bază de beton, pregătiți un pat de nivel pentru un strat ferm de piatră zdrobită. Plăcuța de beton trebuie apoi turnată la o grosime de 4 inci (100 mm) până la 5 inci (125 mm). Lăsați-l să se usuce bine timp de cel puțin 48 de ore. Producătorul nu este responsabil pentru alegerea și construirea fundației.**

**BG** За да сте сигурни, че Вашата барака издържа високи ветрове, препоръчваме да използвате тази опция за пода. За подходяща подова основа се препоръчва използването на бетонна подложка или големи бетонни квадратни плочки. Уверете се, че тя е здрава и равна и ще позволи дренаж далеч от мястото. Направете нивелирана бетонна основа, която има външен размер от 103 3/8" x 72 1/4" (2620mm x 1835mm) за основен навес. **За бетон основа на подложка, подгответе ниво легло за твърда основа слой от натрошен камък. След това бетонната подложка трябва да се излива на дебелина от 4 инча (100 мм) до 5 инча (125 мм). Оставете да изсъхне напълно за поне 48 часа. Производителят не носи отговорност за избора и изграждането на основата.**

**TR** Sunduğunuzdan yüksek rüzgarlara dayanıklı olmasını sağlamak için bu zemin seçeneğini kullanmanızı öneririz. Uygun taban tabanı için beton bir yastık veya büyük boy bir beton bahçe avlusu karosu önerilir. Sert ve sağlam olduğundan ve drenajın yerinden uzaklaşmasına izin vereceğinden emin olun. Basic Shed için dış boyut 103 3/8" x 72 1/4" (2620mm x 1835mm) olan düz bir beton temel oluşturun. **Beton pad taban için, ezilmiş taştan sağlam bir taban tabakası için düz bir yatak hazırlayın. Beton pedi daha sonra 4 inç (100mm) ila 5 inç (125mm) arasındaki bir kalınlığa dökülmelidir. En az 48 saat boyunca iyice kurummasına izin verin. Üretici, vakfın seçimi ve yapımı için sorumlu değildir.**

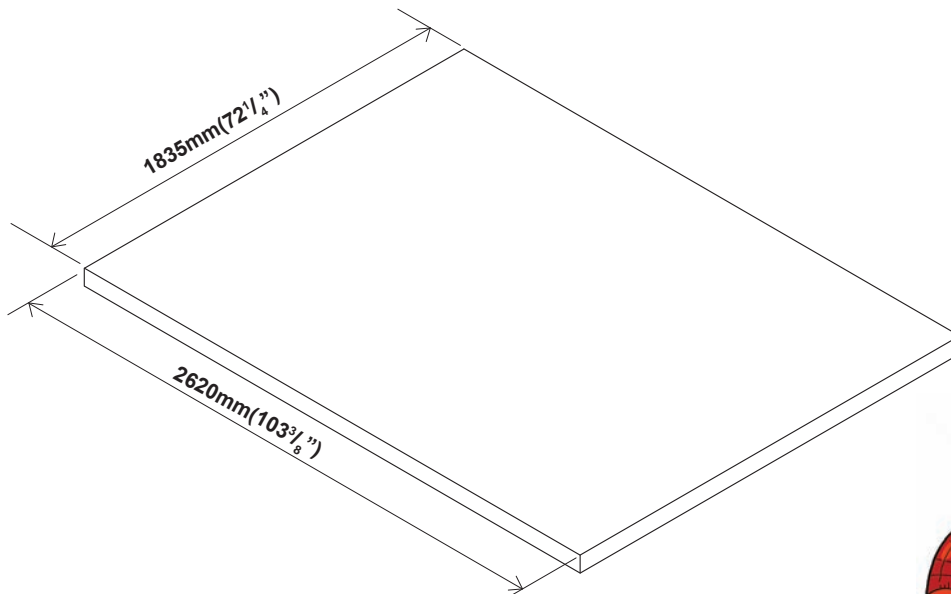

- EN** 1. Set the Torque limit of your Screw drill to #3 or #4 to ensure the Screws do not strip the Metal reinforcements.  
2. It is important that these instructions are followed step by step.  
3. Don't install under windy conditions.  
4. All panels are clearly marked and care should be taken to use the correct one.  
5. Use screws with plastic washers on top of prepainted surface only.
- FR** 1. Réglez la limite de couple de votre perceuse Vis à n° 3 ou n° 4 pour s'assurer que les vis ne suppriment pas les renforts métalliques.  
2. Il est important que ces instructions soient suivies pas à pas.  
3. Ne pas installer sous conditions de vent.  
4. Toutes les parois sont clairement identifiées et il faut veiller à utiliser la bonne.  
5. Utilisez des vis avec des rondelles en plastique sur le dessus de la surface pré peinte seulement.
- DE** 1. Stellen Sie die Torque Limit Ihres Schraube Bohrer # 3 oder # 4, um die Schrauben sicher nicht stripfen die Metallverstärkungen.  
2. Diese Anleitung muss unbedingt Schritt für Schritt befolgt werden.  
3. Die Montage nicht bei windigem Wetter vornehmen.  
4. Alle Platten sind deutlich gekennzeichnet, und es sind unbedingt jeweils die richtigen Platte zu verwenden.  
3. Benutzen Sie bei lackierten Oberflächen nur Schrauben mit Plastikunterlegscheiben.
- ES** 1. Establecer el límite de par de su taladro tornillo de # 3 y # 4 para asegurar los tornillos no tira los refuerzos metálicos.  
2. es importante que estas instrucciones se sigan paso a paso.  
3. No instale en días de mucho viento.  
4. Todos los paneles están claramente señalizados y asegúrese de seleccionar el correcto en cada momento del montaje.  
5. Use los tornillos y las arandelas plásticas solo en las partes prepintadas.
- PT** 1. Defina o limite de Torque de sua broca parafuso para # 3 ou # 4 para garantir que os parafusos não tira os reforços de metal.  
2. É importante que estas instruções sejam seguidas passo a passo.  
3. Não instale sob condições com forças ventanosas.  
4. Todos os painéis estão claramente marcados, um cuidado deve ser tomado para o uso correcto.  
5. Utilize parafusos com anilhas plásticas em cima da superfície prepainted apenas.
- NL** 1. Stel de Torque limiet van uw Schroef boormachine op # 3 en # 4 om de schroeven zorgen niet strip de Metal versterkingen.  
2. Het is belangrijk dat volgende instructies stap voor stap worden gerespecteerd.  
3. Nooit de schuur installeren onder winderige omstandigheden.  
4. Markeer alle panelen zorgvuldig en gebruik altijd de juiste panelen.  
5. Gebruik schroeven met plasticen ring aan de bovenkant of voor gelakt ondergrond.
- CS** 1. Nastavte mezní hodnotu točivého momentu vrtacího vrtáku na #3 nebo #4, abyste zajistili, že šrouby neztáhnou kovové výztuhy.  
2. Je důležité aby jste tento návod sledovali krok za krokem.  
3. Nemontujte při větrném počasí.  
4. Každý panel je označen a musíte dávat pozor zda používáte ten správný.  
5. používejte šrouby z plastovým těsněním pouze na natřenou plochu.
- SK** 1. Nastavte limit krútiaceho momentu vŕtacieho vŕtáka na #3 alebo #4, aby ste zaistili, že skrutky nezaberajú kovové výstuhy.  
2. Je nutné dodržiavať tieto inštrukcie krok za krokom.  
3. Neinštalujte za veterných podmienok.  
4. Všetky panely sú jasne označené a pozorne si treba vybrať ten správny.  
5. Použite skrutky s plastovými podložkami len na natretú plochu.
- SL** 1. Za omejitev vrtilnega momenta vijaknega vijaka nastavite #3 ali #4, da zagotovite, da vijaki ne ojačitijo kovinskih ojačitev.  
2. Pomembno je, da sledite opisanim navodilom korak za korakom.  
3. Montaže ne izvijajte, kadar piha močen veter.  
4. Vse plošče so jasno označene. Paziti je treba, da vzamete vsakokrat pravilno ploščo.  
5. Uporabite vijake s plastičnimi podložkami samo na vrhu grundirane površine.
- HR** 1. Postavite granicu zakretnog momenta Vašeg vijčanog bušilica na #3 ili #4 kako biste osigurali da vijci ne skidaju metalna pojačanja.  
2. To je važno da ovih instrukcije su slijedili korak po korak.  
3. Nemojte instalirati pod vjetrovitim uvjetima.  
4. Svi paneli su jasno označene i brigu treba poduzeti kako bi se koristiti ispravan panel  
5. Koristite vijaka sa plastičnim podmetakima na vrhu od unaprijed - obojana površinska.
- HU** 1. Állítsa a csavarhúzó nyomatékhatárait #3 vagy #4-re, hogy a csavarok ne csavarják le a fém vasalatokat  
2. Fontos, hogy az itt következő instrukciókat lépésről lépésre betartsa.  
3. Szeles időben ne végezzen összeszerelést.  
4. Minden panel egyértelműen meg van jelölve, ügyeljen arra, hogy a megfelelőt használja.  
5. Előre festett felületeken csak műanyag alátétekkel használja a csavarokat.
- SV** 1. Ställ in momentskruven på din skruvborr till #3 eller #4 för att säkerställa att skruvarna inte slår av metallförstärkningarna.  
2. Det är viktigt att dessa instruktioner följs steg för steg.  
3. Installera inte när det är blåsigt.  
4. Alla paneler är tydligt markerade och försiktighet bör vidtas för att använda rätt.  
5. Använd skruvarna med plastskivor endast på förmålad yta.
- IT** 1. Impostare il limite di coppia della fresa a vite a #3 o #4 per assicurare che le viti non striscia i rinforzi metallici  
2. E' molto importante che queste istruzioni vengano seguite passo dopo passo.  
3. Non installare in presenza di forte vento.  
4. Tutti i pannelli sono chiaramente contrassegnati e bisogna fare attenzione a usare quello corretto.  
5. Usare viti con rondelle di plastica solo sulla superficie pre-verniciata.
- PL** 1. Zestaw limit momentu obrotowego twój śruby wiercenia do # 3 lub # 4, aby upewnić się, że śruby nie taśmy wzmocnień  
2. Bardzo ważne jest, by dokładnie stosować się do niniejszej instrukcji.  
3. Nie należy montować w przypadku silnego wiatru.  
4. Wszystkie panele ściennie są dokładnie oznakowane i należy zwrócić uwagę, aby używać właściwych elementów.  
5. Używaj śrub z plastikowymi uszczelkami wyłącznie na wcześniej pomalowanej powierzchni.
- RO** 1. Setati limita de cuplu a burghiului dvs. de șurub la #3 sau #4 pentru a vă asigura că șuruburile nu lărgește armăturile metalice.  
2. Este importantă respectarea pas cu pas a acestor instrucțiuni.  
3. Nu instalați dacă vântul atinge viteze mari.  
4. Toate panourile sunt clar marcate și trebuie avut grijă să se folosească cel corect.  
5. Folosiți șuruburi cu șaibe de plastic doar pe suprafața prevopsită.
- BG** 1. Нагласете границата на въртящия момент на винтовата витла до #3 или #4, за да се уверите, че винтовете не изрязват металните подсилвания.  
2. Важно е да следвате инструкциите стъпка по стъпка.  
3. Да не се монтира при ветровито време.  
4. Всички панели са ясно маркирани и трябва да се внимава за правилното използване на всеки от тях.  
5. Използвайте винтове с пластмасови шайби само върху предварително боядисани повърхности.
- TR** 1. Vidaların Metal takviyeleri soymadığından emin olmak için Vidalı matkabınızın Moment sınırını #3 veya #4'e ayarlayın.  
2. Talimatların sırasıyla uygulanması önemlidir.  
3. Rüzgarlı havalarda kurmayınız.  
4. Bütün paneller dikkatlice işaretlenmeli ve doğru olanın kullanıldığına dikkat edilmelidir.  
5. Önceden boyanmış yüzey için sadece Vida ve plastik pul kullanınız.





- 1**
- |                       |                    |                      |
|-----------------------|--------------------|----------------------|
| EN Base Frame         | CS Základní kostra | IT Cornice di Base   |
| FR Canaux de base     | SK Základňový rám  | PL Rama fundamentowa |
| DE Bodenrahmen        | SL Osnovni okvir   | RO Rama bazei        |
| ES Armazón de la base | HR Baza okvir      | BG Основна Рама      |
| PT Base de armação    | HU Alapváz         | TR Temel Çerçevesi   |
| NL Basis frame        | SV Basram          |                      |

- |                       |                                   |                                   |
|-----------------------|-----------------------------------|-----------------------------------|
| EN Parts needed       | CS Potřebné součásti              | IT Parti occorrenti               |
| FR Pièces nécessaires | SK Potrebné časti                 | PL Niezbędne elementy             |
| DE Benötigte Teile    | SL Dele, ki jih boste potrebovali | RO Elementele componente necesare |
| ES Piezas necesitadas | HR Dijelovi potreban              | BG Необходими части               |
| PT Peças Necessárias  | HU Szükséges részek               | TR Gerekli parçalar               |
| NL Onderdelen nodig   | SV Delar som behövs               |                                   |

MB01	1
MB02	1
MB03	2
MB04	1
MA05	2
MA07	4
S1	24

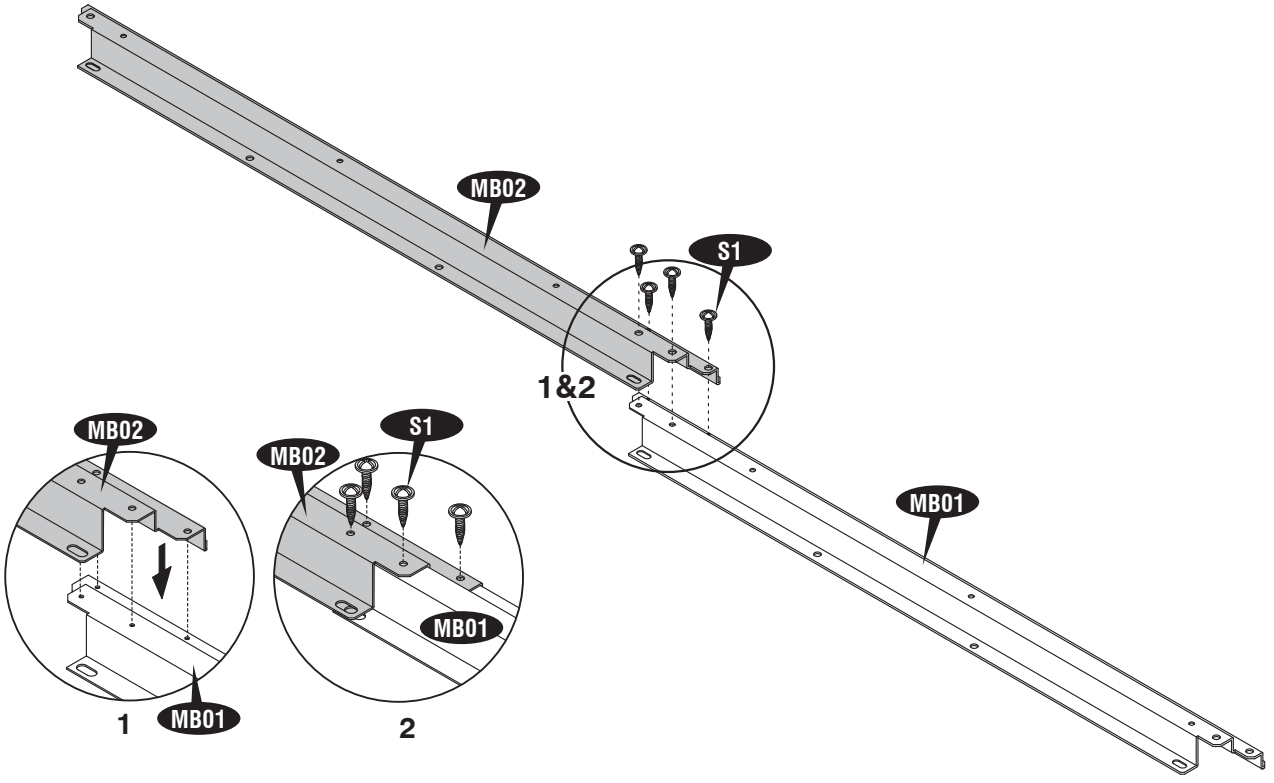
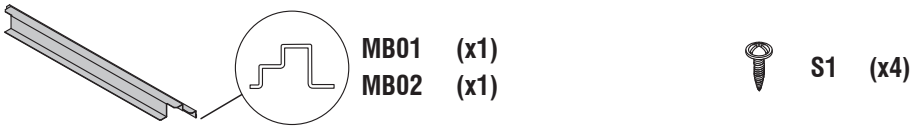

2

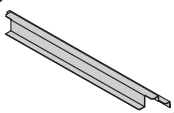

MB03 (x2)

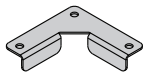

MA07 (x2)



S1 (x8)

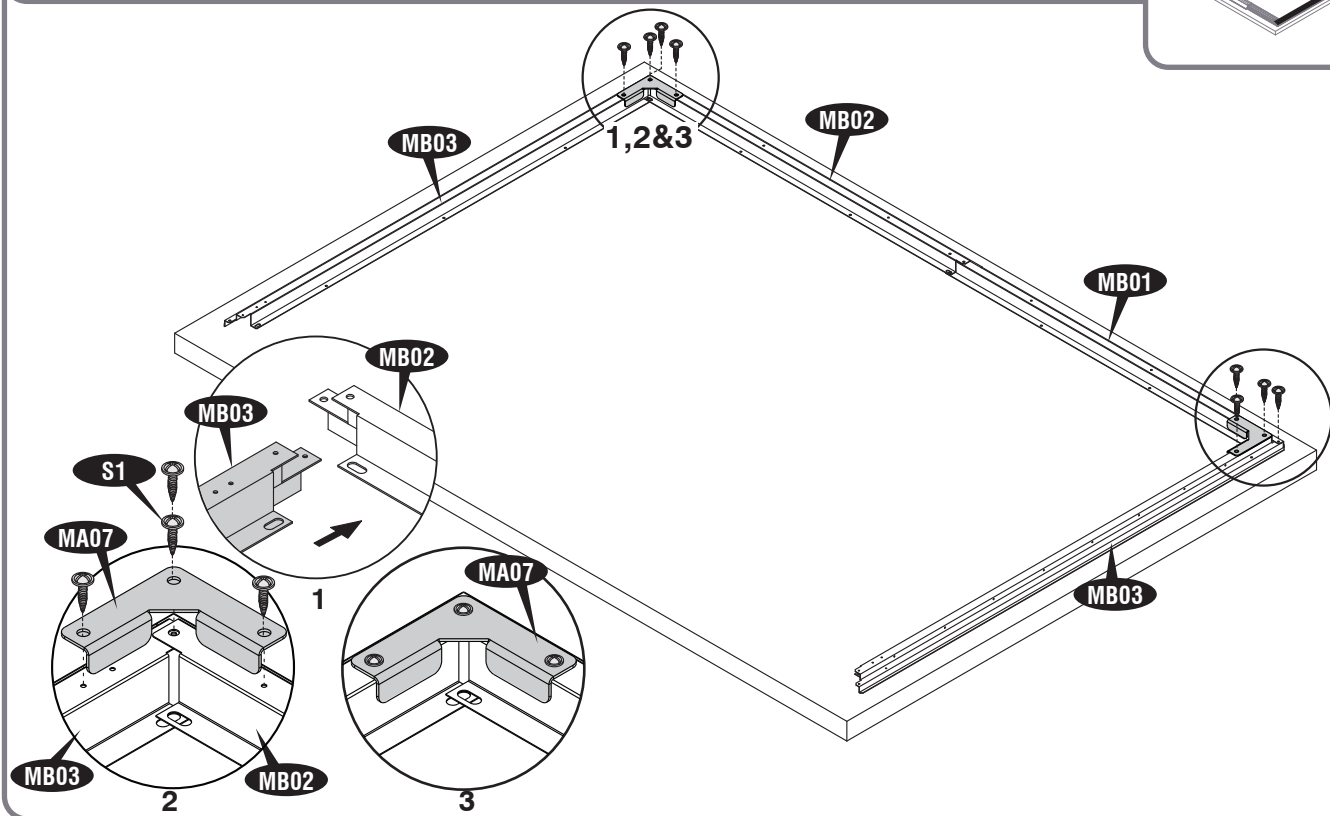

3

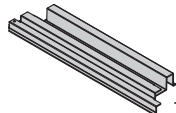

MA05 (x2)

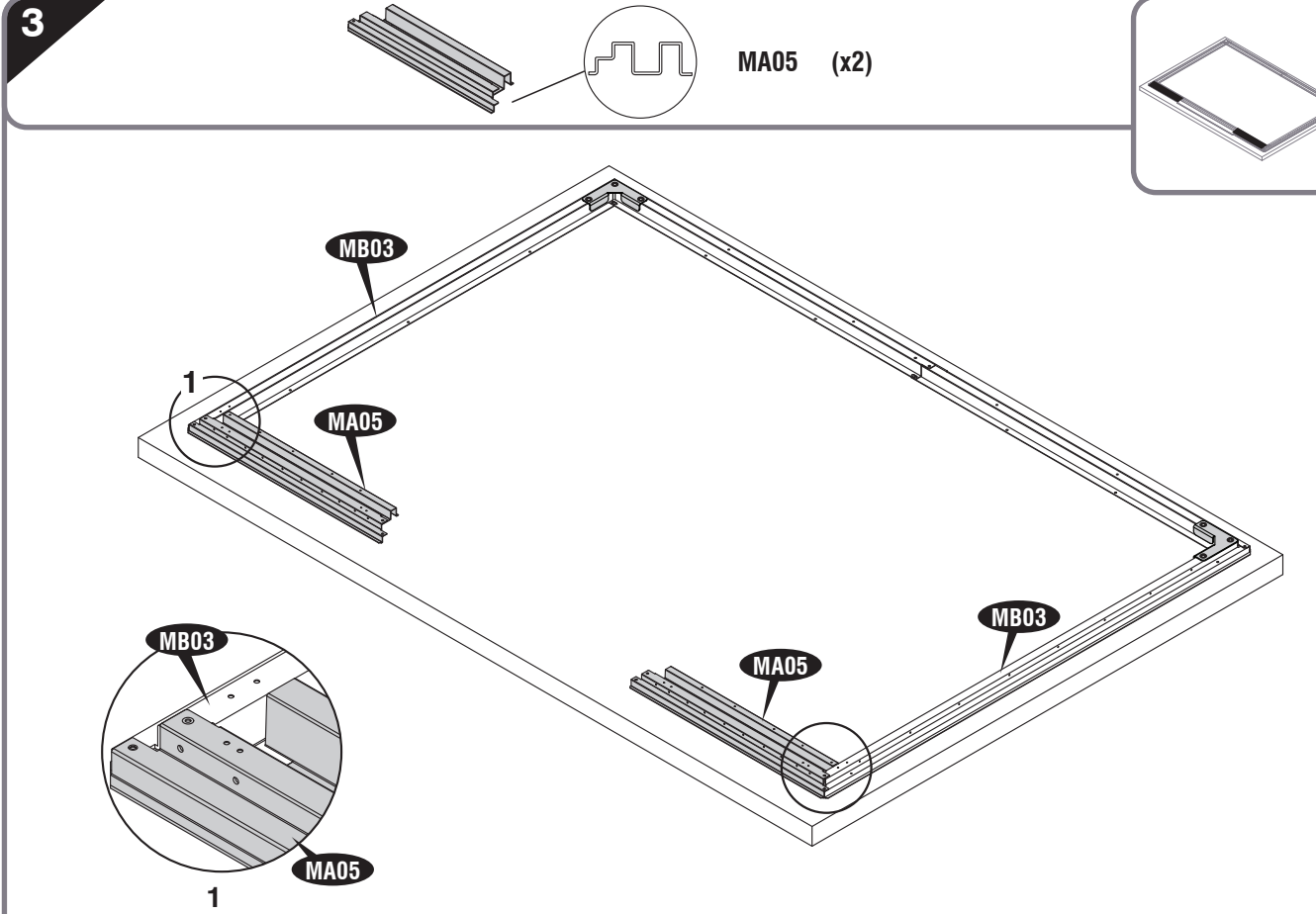
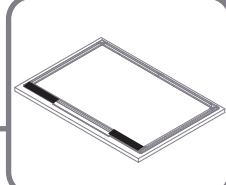

4

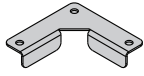

MA07 (x2)



S1 (x8)

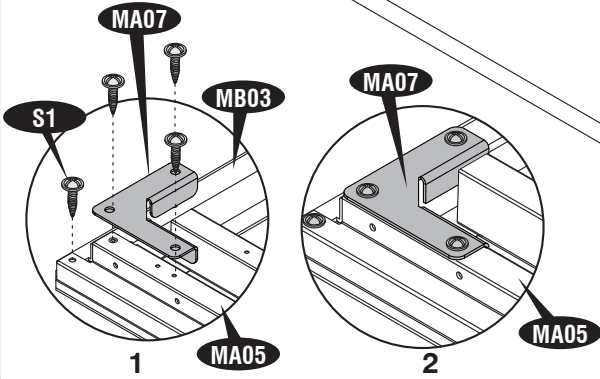
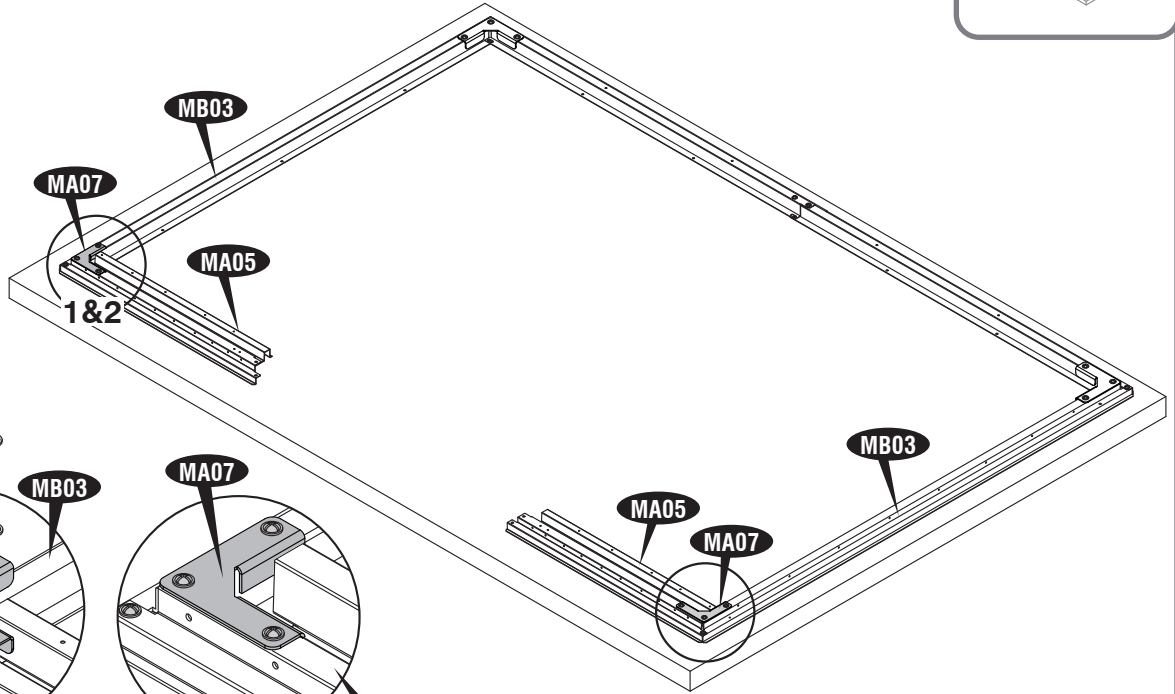
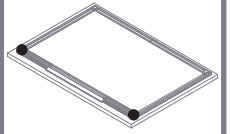

5

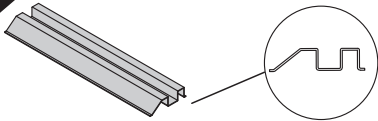

MB04 (x1)



S1 (x4)

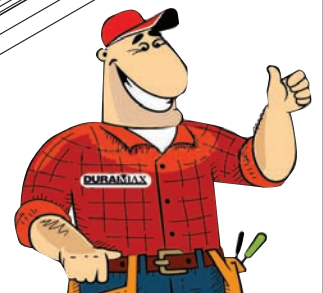
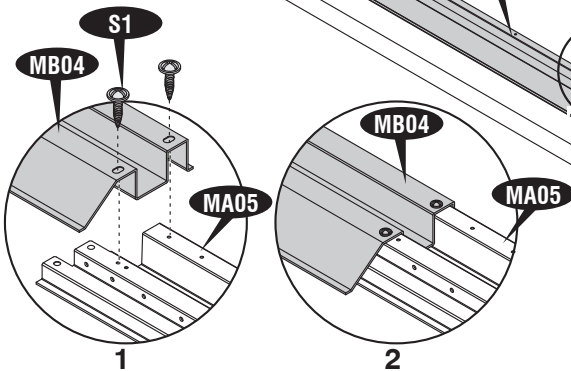
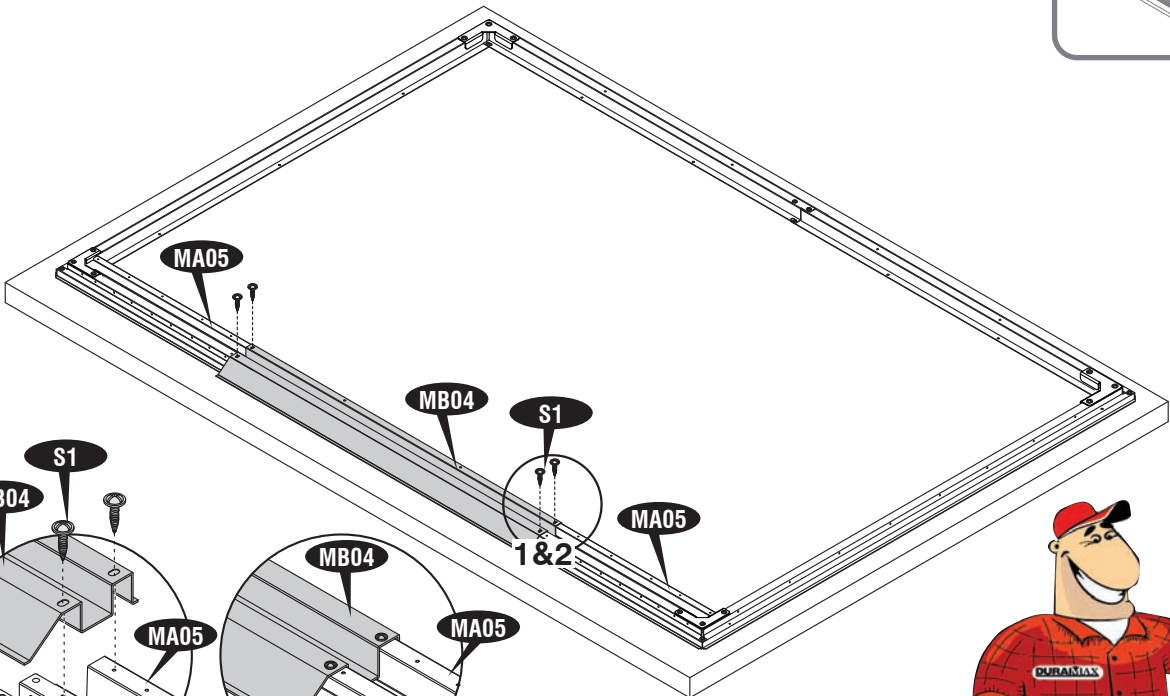
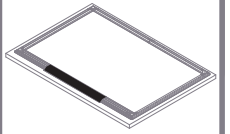



- 2**
- |                       |                      |                        |
|-----------------------|----------------------|------------------------|
| EN Walls & Columns    | CS Zdi a kolumny     | IT Pareti & Colonne    |
| FR Murs et colonnes   | SK Steny a stĺpy     | PL Ściany i Kolumny    |
| DE Wände und Säulen   | SL Stene in stebri   | RO Pereți și stâlpi    |
| ES Columnas y paredes | HR Zidovi i Kolumne  | BG Стени & Колони      |
| PT Paredes e Colunas  | HU Falak és oszlopok | TR Duvarlar & Sütunlar |
| NL Panelen en stijlen | SV Väggar & Kolumner |                        |

- |                       |                                   |                                   |
|-----------------------|-----------------------------------|-----------------------------------|
| EN Parts needed       | CS Potřebné součásti              | IT Parti occorrenti               |
| FR Pièces nécessaires | SK Potřebné části                 | PL Niezbędne elementy             |
| DE Benötigte Teile    | SL Dele, ki jih boste potrebovali | RO Elementele componente necesare |
| ES Piezas necesitadas | HR Dijelovi potreban              | BG Необходими части               |
| PT Peças Necessárias  | HU Szükséges részek               | TR Gerekli parçalar               |
| NL Onderdelen nodig   | SV Delar som behövs               |                                   |

ME01	1	MB08	1	MF04	1	ME27	4
ME02	1	MF01	2	ME10	2	ME28	6
MB05	1	MB10	1	ME11	2	MA47	4
MB06	1	ME05	2	ME12	1	PW	119
MA12	1	MF02	2	ME13	1	S1	145
MB07	1	MF03	1	ME26	2	S3	4

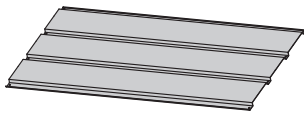

ME26 (x1)



S1 (x2)



PW (x2)

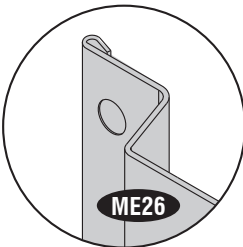

1

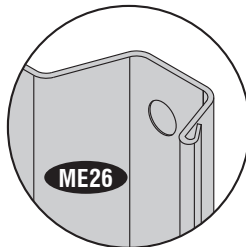

2

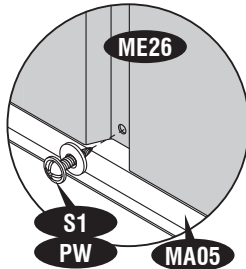

3

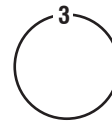
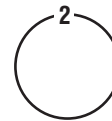
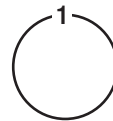

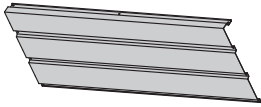

ME27 (x1)



S1 (x3)



PW (x3)

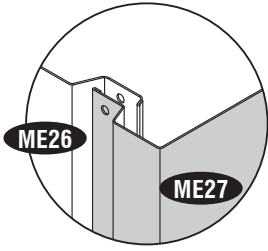

ME26

ME27

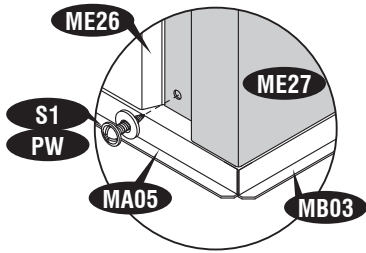

ME26

ME27

S1

PW

MA05

MB03

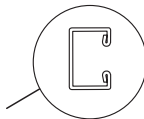

MB06 (x1)



S1 (x3)



PW (x3)

4

ME12 (x1)

ME13 (x1)

ME05 (x2)

S1 (x2)

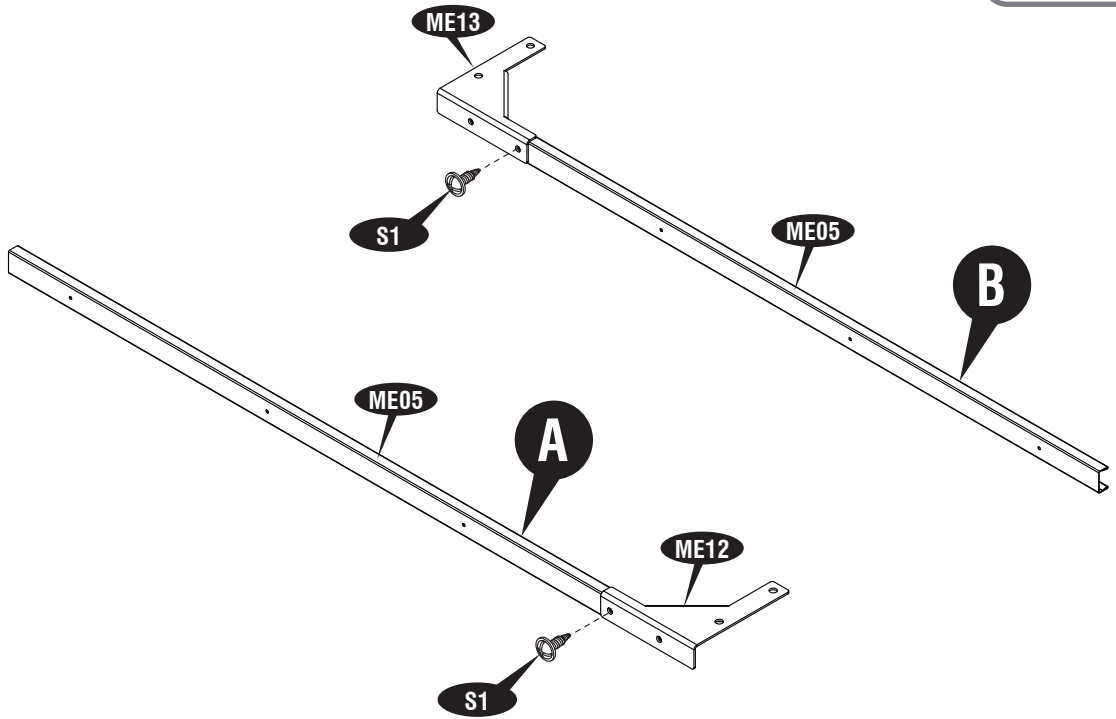
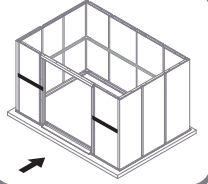

5

MF03 (x1)  
MF04 (x1)

ME10 (x1)

S1 (x4)

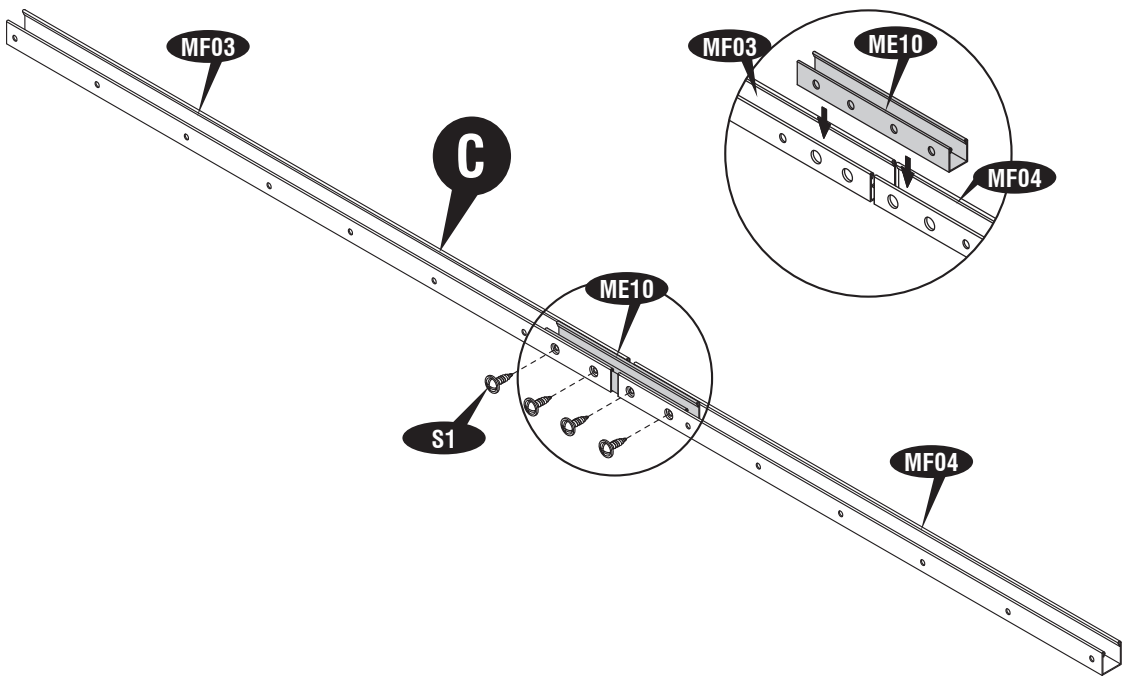
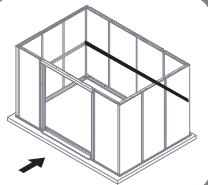

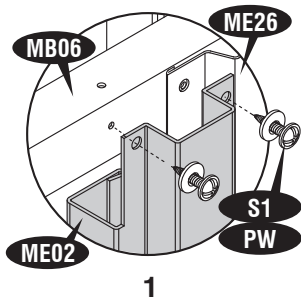
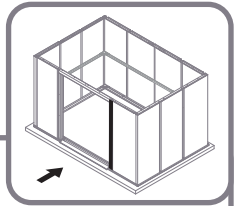
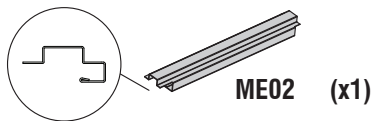
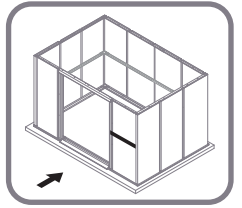

1

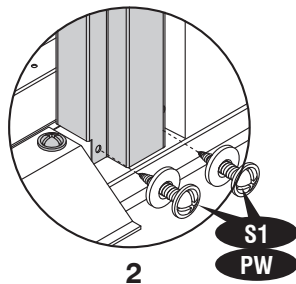

2

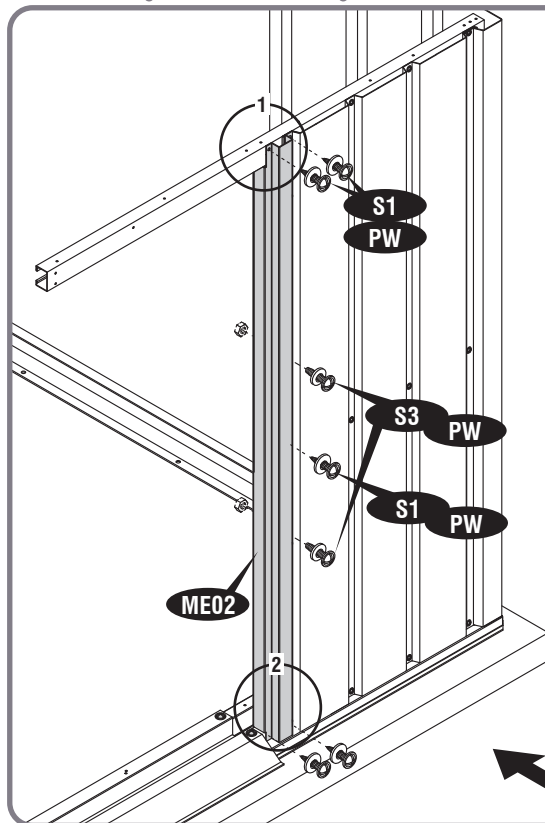



10

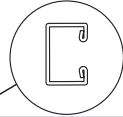
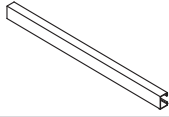

MB05 (x1)



S1  
PW



11



12



13



25

14

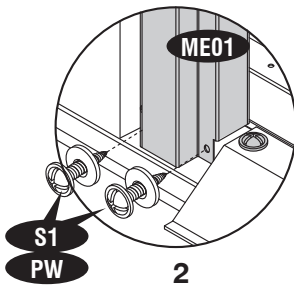
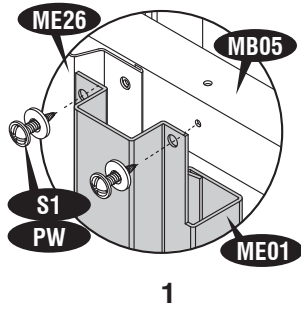
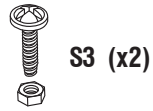
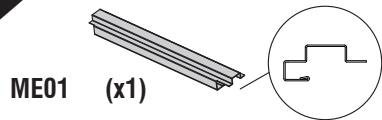

15



16



17

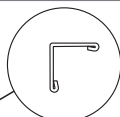
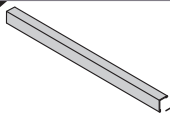

MB07 (x1)



S1 (x3)

PW (x3)



27

18



19



S1 (x6)

PW (x4)



28

20

S1



21

29

22



23



30

24



25



31

26

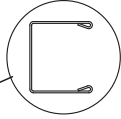
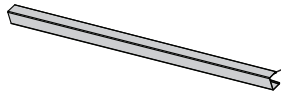

MF02 (x1)



S1 (x6)



PW (x4)

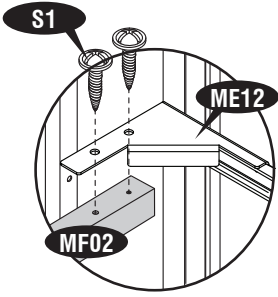

1

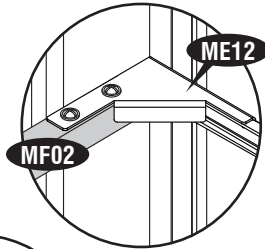

2

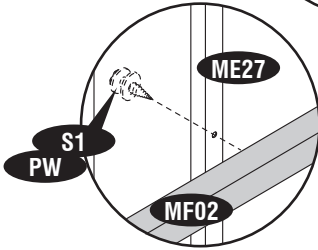

3

S1  
PW



27

S1

32

28

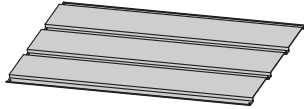

ME28 (x1)



S1 (x12)



PW (x12)

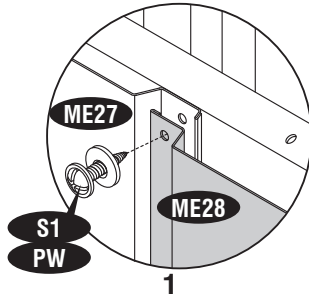
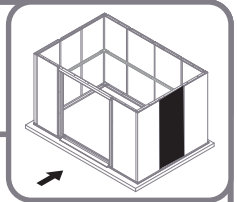

1

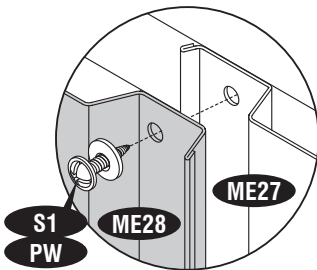

2

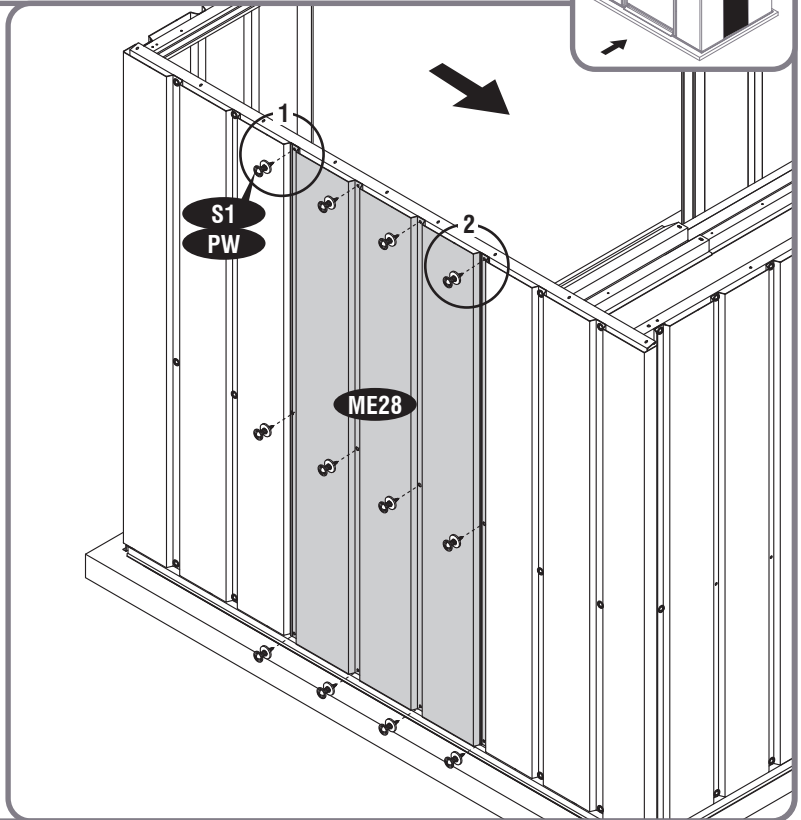

29



S1 (x10)



PW (x6)

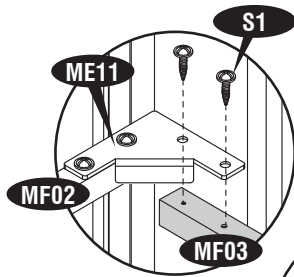
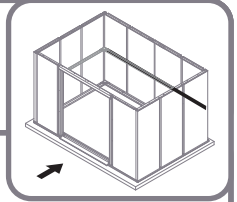

1

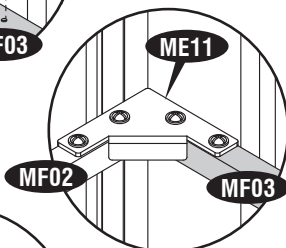

2

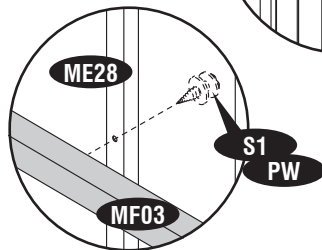

3

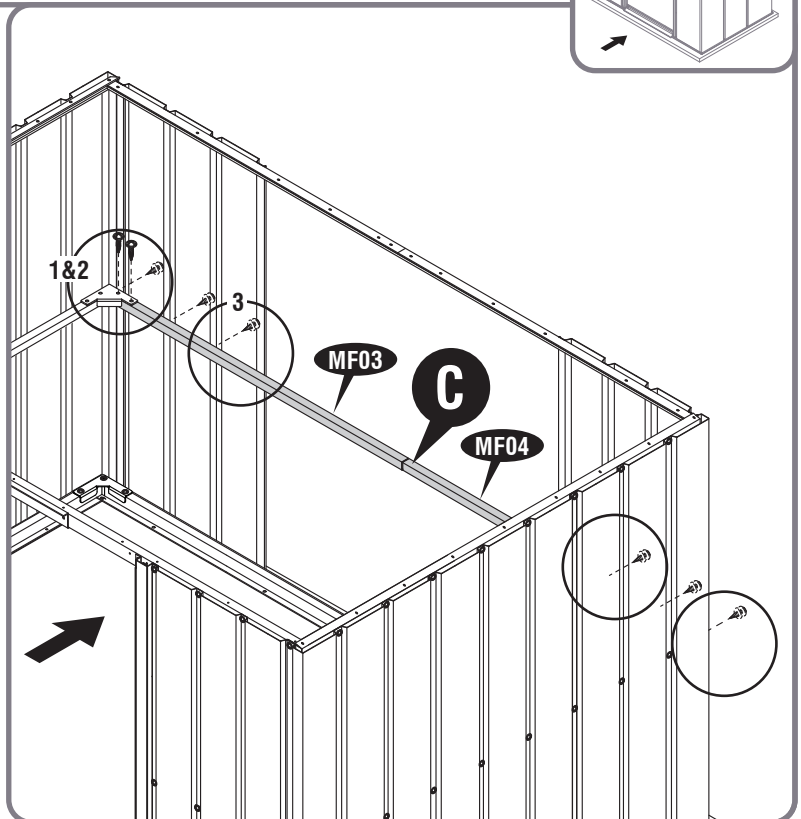

33

30



31



34

32

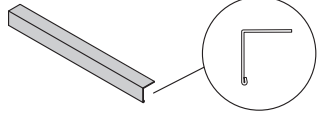

MB10 (x1)

S1 (x2)

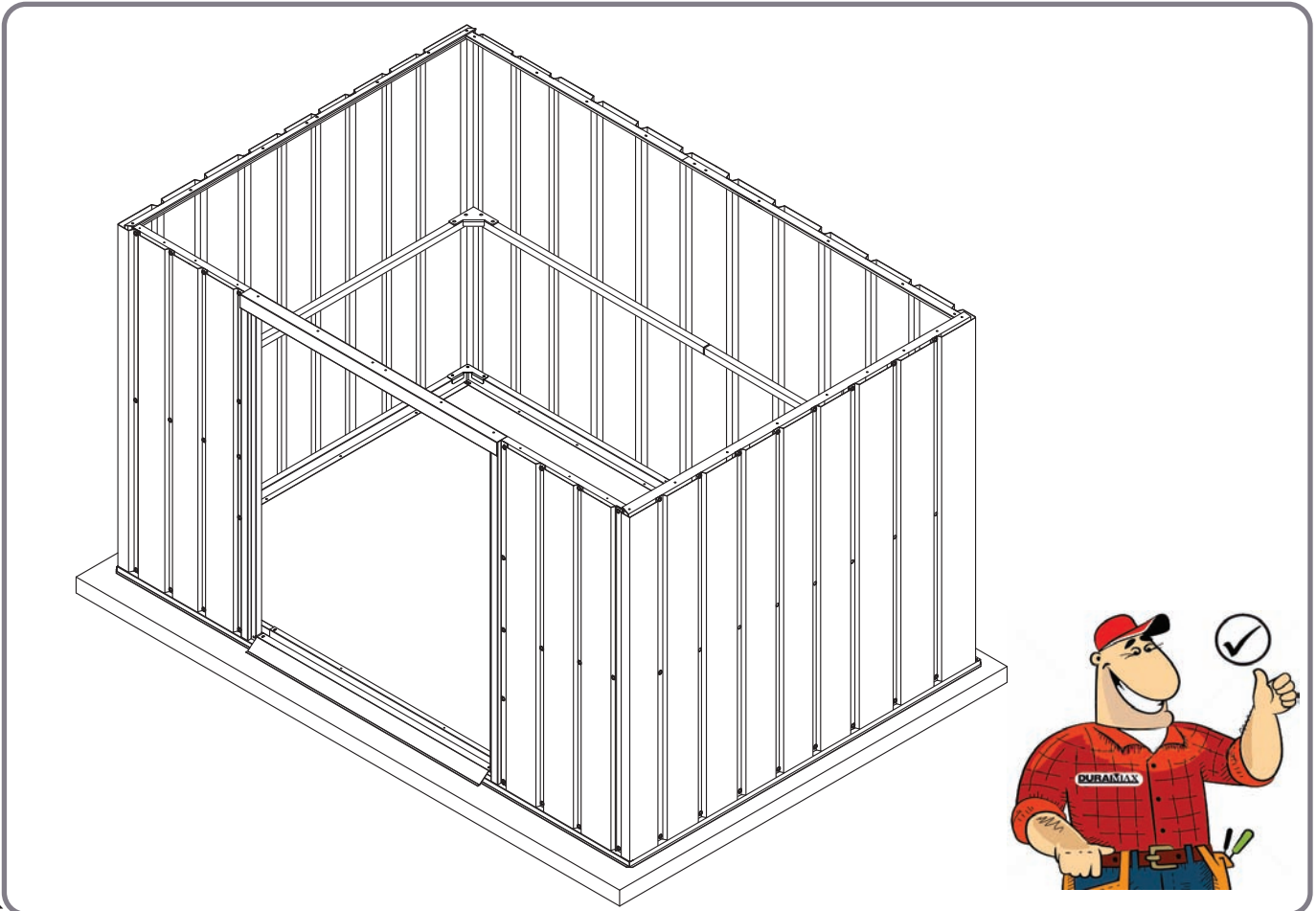
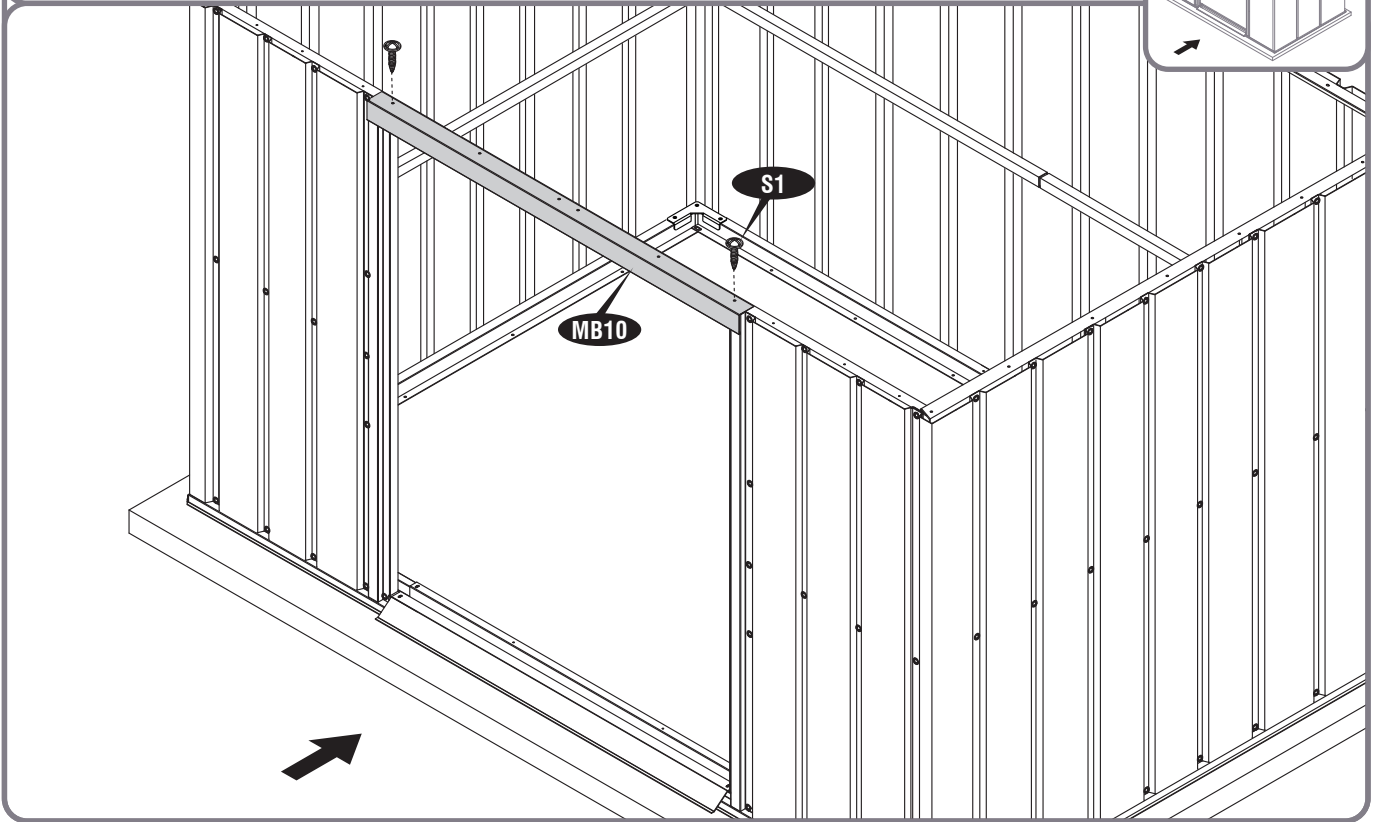
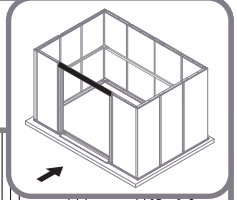

35



3

- |             |            |               |
|-------------|------------|---------------|
| EN Roof     | CS Střecha | IT Soffitto   |
| FR Toit     | SK Strecha | PL Dach       |
| DE Dach     | SL Streha  | RO Acoperișul |
| ES El techo | HR Krov    | BG Покрив     |
| PT Telhado  | HU Tető    | TR Çatı       |
| NL Dak      | SV Tak     |               |

- |                       |                                   |                                   |
|-----------------------|-----------------------------------|-----------------------------------|
| EN Parts needed       | CS Potřebné součásti              | IT Parti occorrenti               |
| FR Pièces nécessaires | SK Potřebné části                 | PL Niezbędne elementy             |
| DE Benötigte Teile    | SL Dele, ki jih boste potrebovali | RO Elementele componente necesare |
| ES Piezas necesitadas | HR Dijelovi potreban              | BG Необходими части               |
| PT Peças Necessárias  | HU Szükséges részek               | TR Gerekli parçalar               |
| NL Onderdelen nodig   | SV Delar som behövs               |                                   |

MA18	2
MF05	2
MF06	3
MF07	1
MF08	2
MF09	2

MF10	2
MF11	2
MB17	2
MB18	2
MF12	2
ME25	2

MF13	2
MF14	2
MF15	2
MF16	2
MF17	2
MA49	2
WST	2.8Mtr

TC	4
PW	102
F1	22
S1	87
S2	38
S3	46
S8	22



1

MF14 (x1)

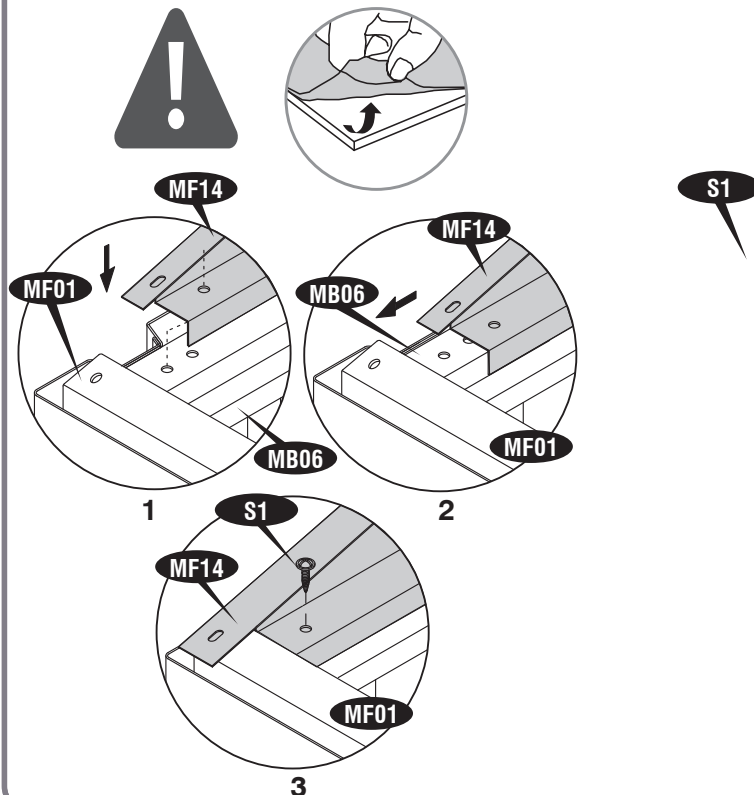
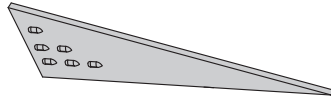

2



3

4

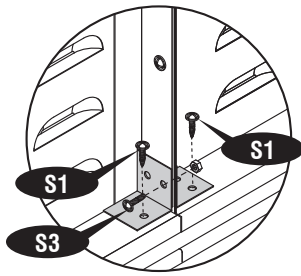
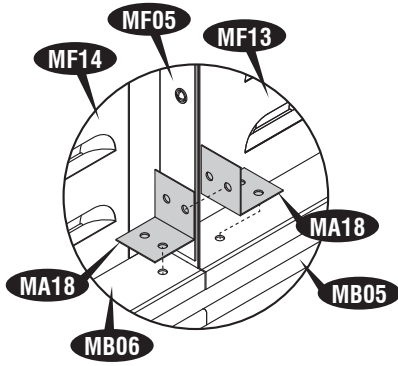
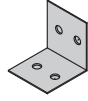

5



6

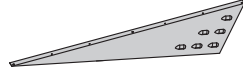

7

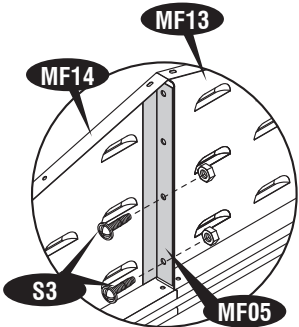
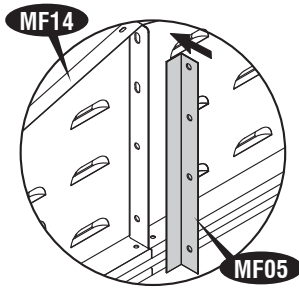

8

MF06 (x2)

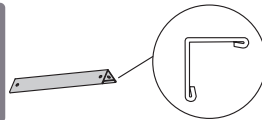
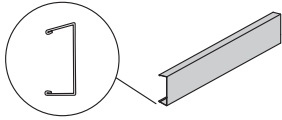

MF08 (x2)  
MF09 (x2)



S3 (x8)

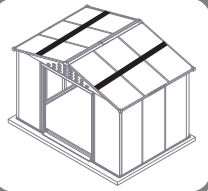

x2

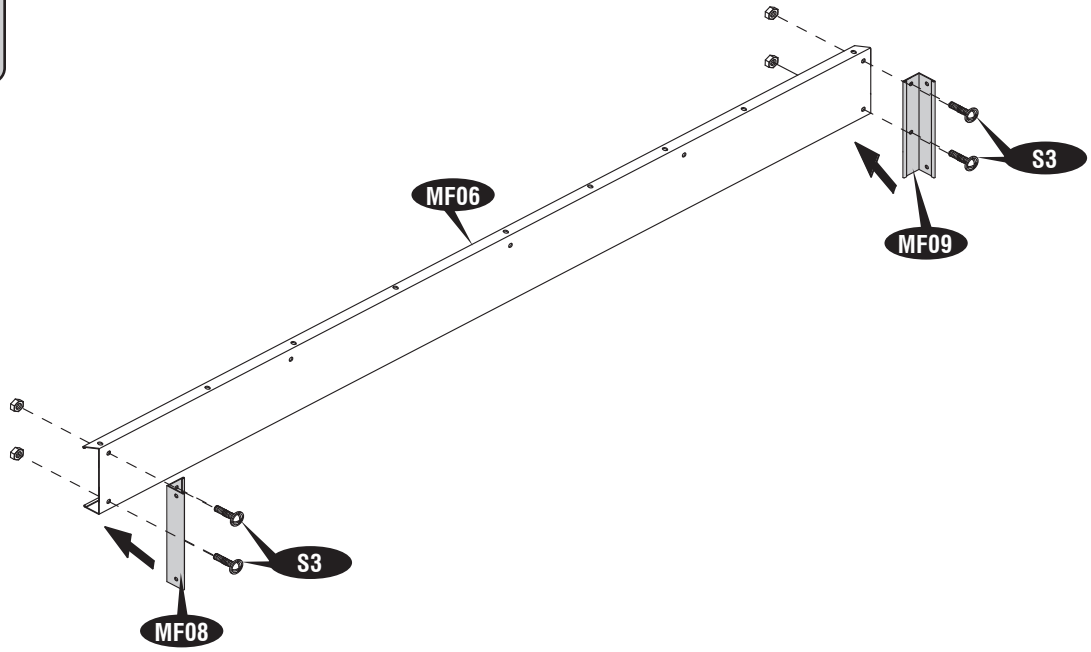

9

MF06 (x1)

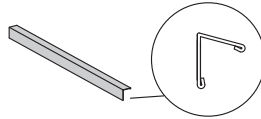
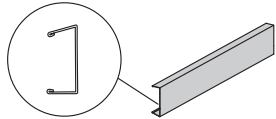

MF07 (x1)



S1 (x3)

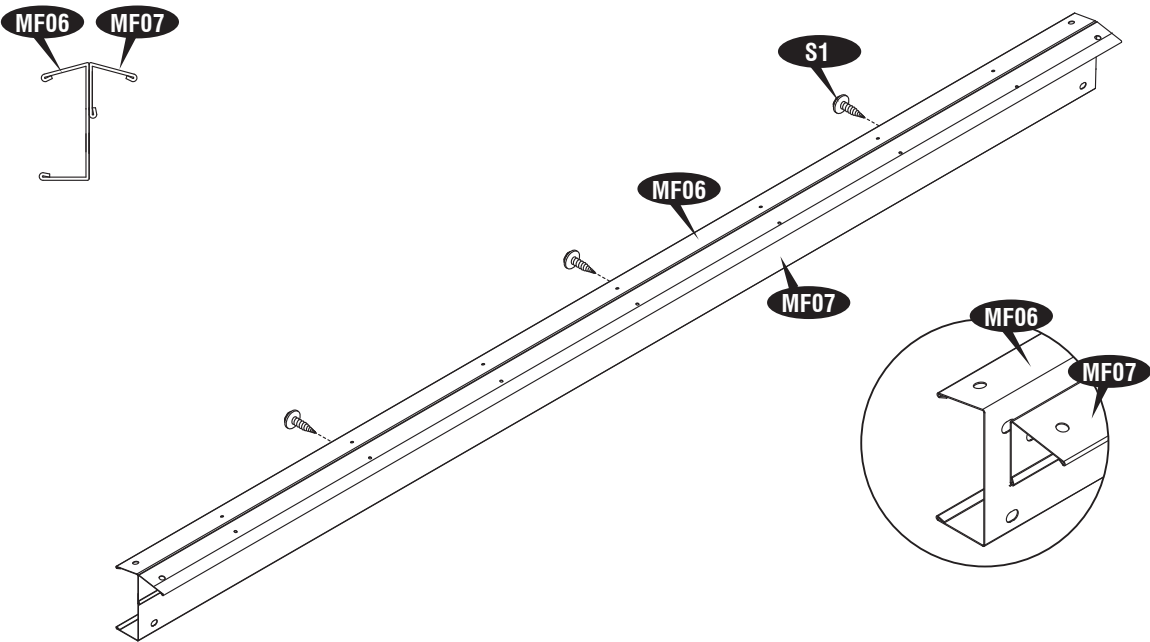
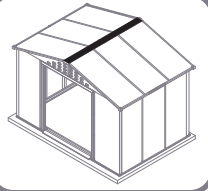

10

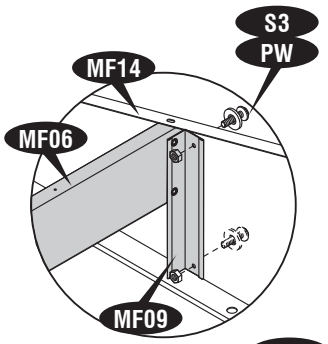

1

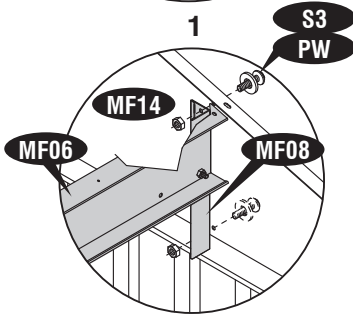

2

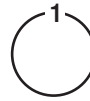

11

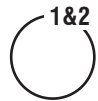

12



13

14

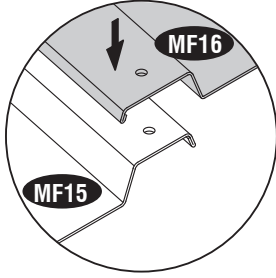

15

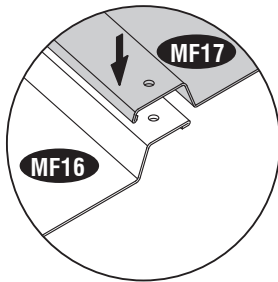

16



17

18

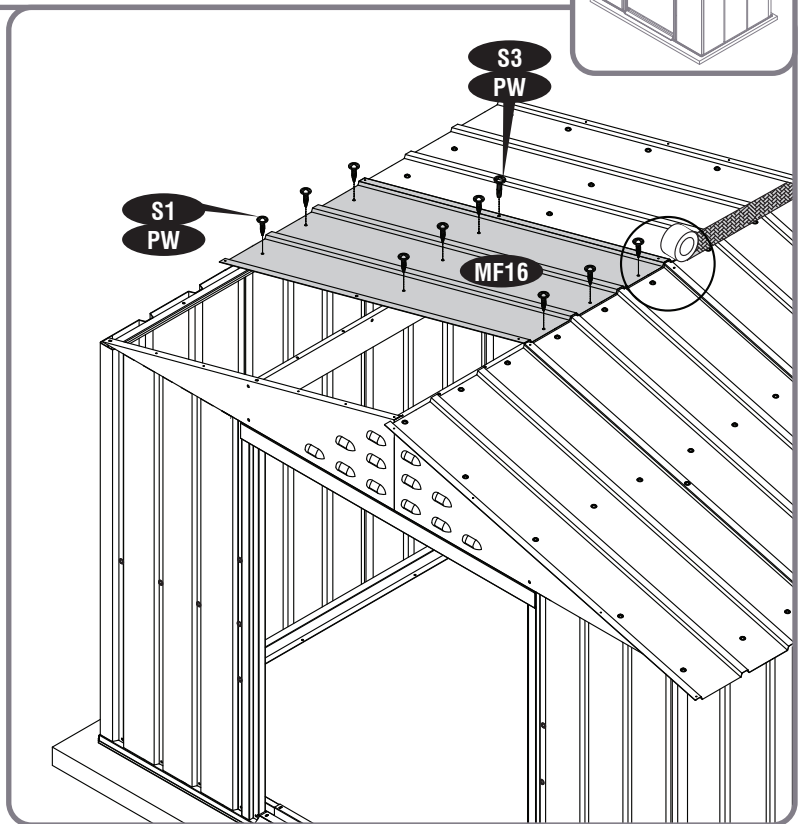
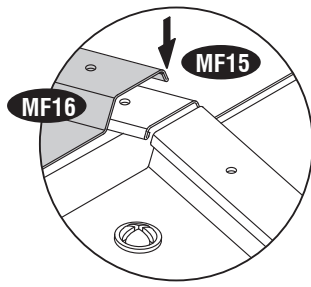
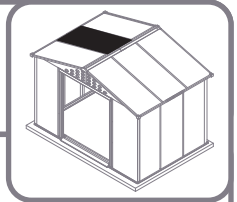

19

20



21

46

22



23

47

24



25

48

Empty rectangular box at the top of the page.



Large empty rectangular box occupying the lower half of the page.

EN Assembly on Wooden platform

FR Ensemble sur plate-forme en bois

DE Montage auf Holzplattform

ES Montaje de la plataforma de madera

PT Montagem em plataforma de madeira

NL Montage op houten platform

CS Montáž na dřevěnou plošinu

SK Montáž na drevenej plošine

SL Montaža na leseni plošči

HR Montaža na drvenoj platformi

HU Összeszerelés faplatformon

SV Montering på träplattform

IT Montaggio su piattaforma in legno

PL Montaż na drewnianej platformie

RO Adunarea pe platforma de lemn

BG Сглобяване на дървена платформа

TR Ahşap platform üzerine montaj



 S2 (x22)

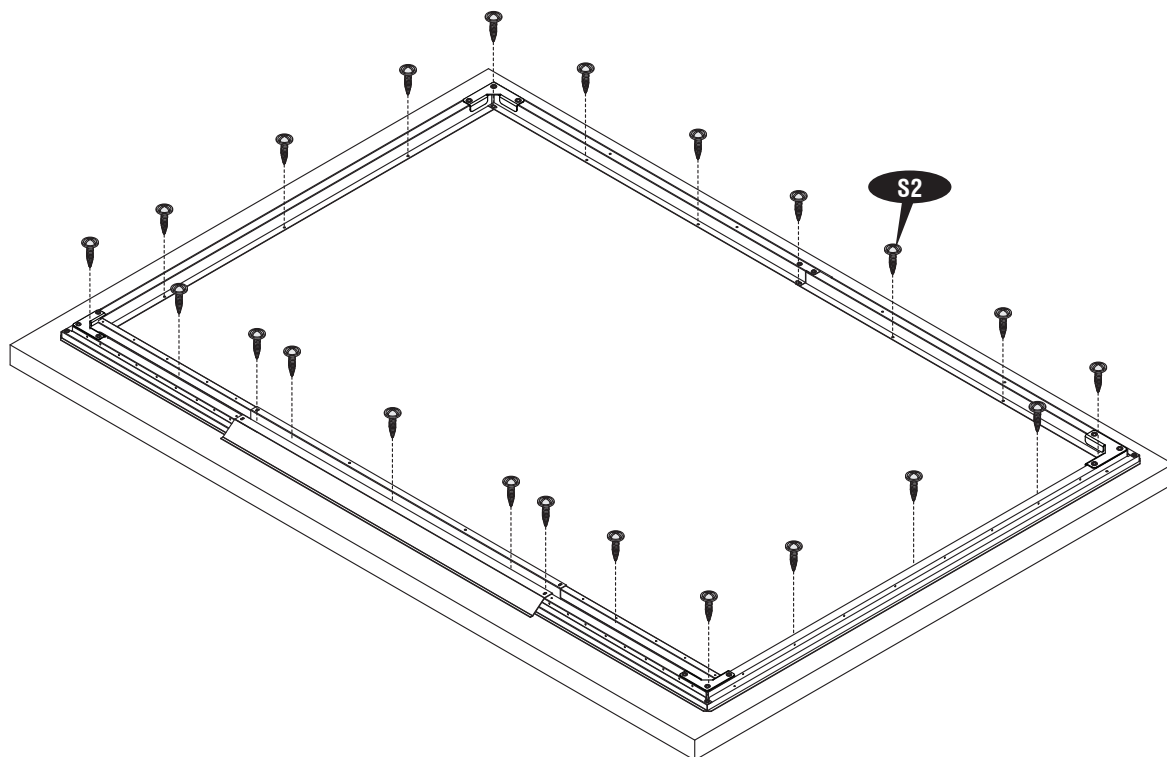

EN Assembly on Concrete Platform

CS Montáž na betonové plošině

IT Montaggio su piattaforma in calcestruzzo

FR Assemblage sur plate-forme en béton

SK Montáž na betónovú plošinu

PL Montaż na betonowej platformie

DE Montage auf Betonplattform

SL Montaža na betonsko ploščad

RO Adunarea pe platforma de beton

ES Montaje sobre la base de hormigón

HR Montaža na betonskoj platformi

BG Монтаж на бетонна платформа

PT Montagem em plataforma de concreto

HU Szerelés beton felületen

TR Beton platform üzerine montaj

NL Montage op betonplatform

SV Montering på betongplattform



F1 (x22)



S8 (x22)

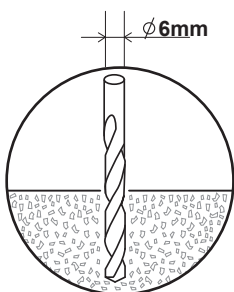

1

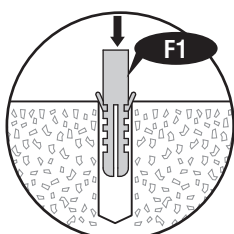

2

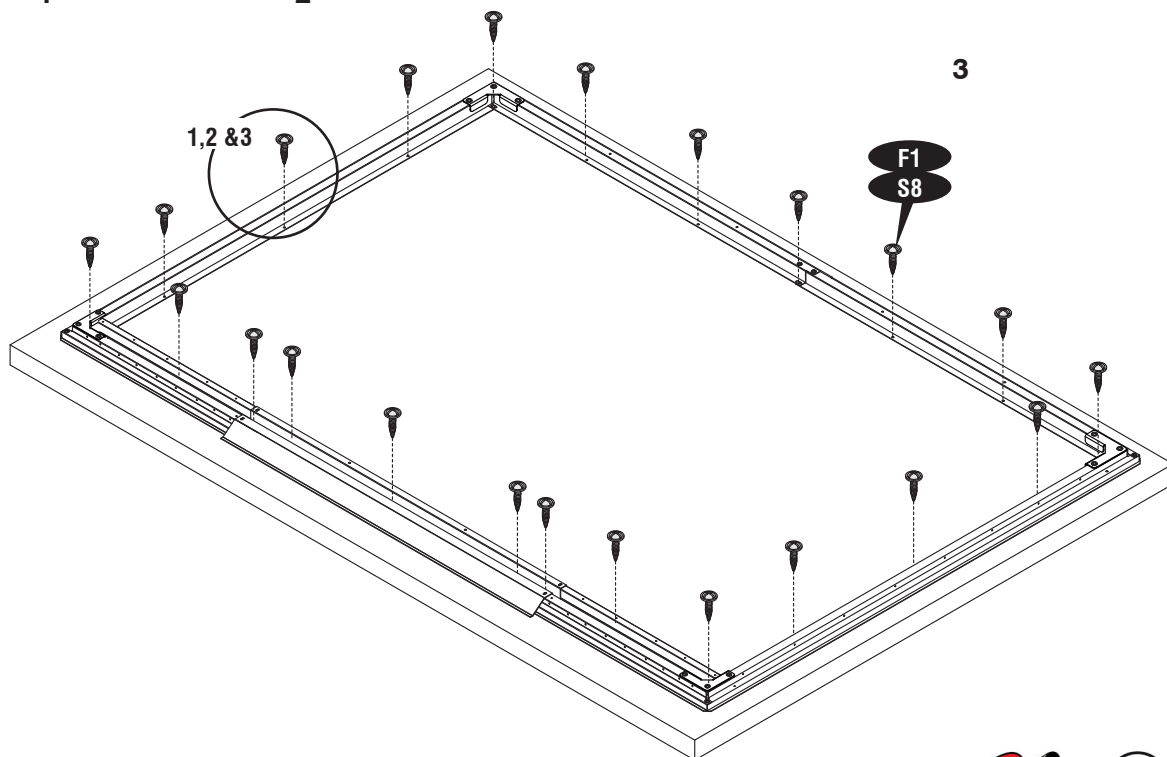

1,2 & 3

3

F1  
S8





1



L

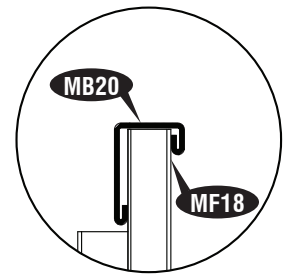
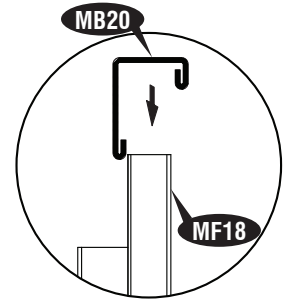

2

L

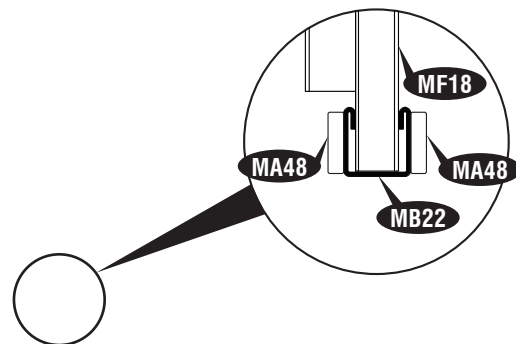

3



L



4

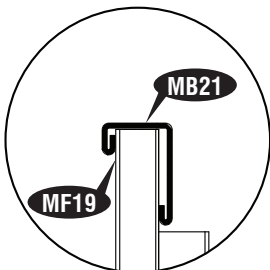
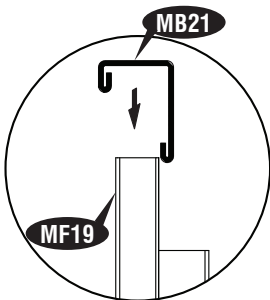
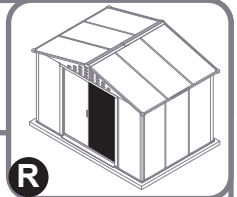

5

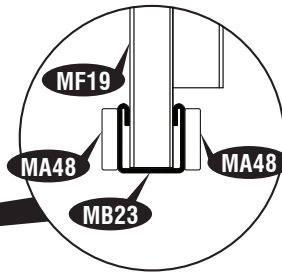
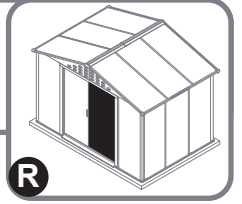

6

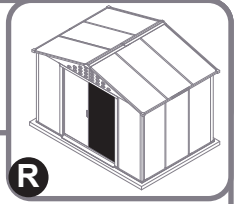







- EN** "For dismantling the Shed, Customer has to follow instructions manual in reverse direction."
- FR** " Pour le démantèlement du hangar, client doit suivre le manuel d'instructions dans le sens inverse."
- DE** In Gebieten mit starken Schneefällen oder starkem Wind empfehlen wir das nachstehende Zubehör.
- ES** "Para el desmantelamiento de la nave, cliente tiene que seguir instrucciones en sentido contrario".
- PT** "Para desmontar o galpão, cliente tem de seguir o manual de instruções em sentido reverso".
- NL** "Voor de ontmanteling van de schuur, klant heeft te volgen instructiehandleiding in omgekeerde richting."
- CS** 'Pro demontáž přístřešku musí zákazník postupovat podle pokynů v opačném směru.'
- SK** 'Pri demontáži prístrešku musí zákazník postupovať podľa pokynov v opačnom smere.'
- SL** 'Za demontažo skladišča mora naročnik slediti priročniku v obratni smeri.'
- HR** 'Za demontažu zida, korisnik mora slijediti priručnike za upute u obrnutom smjeru.'
- HU** 'A fészter lebontásához az Ügyfélnek vissza kell követnie az utasításokat.'
- SV** 'För att demontera Shed måste kunden följa instruktionsboken i omvänd riktning.'
- IT** 'Per lo smontaggio del capannone, il cliente deve seguire manualmente le istruzioni in senso inverso'..
- PL** do demontażu szopy, należy postępować zgodnie z instrukcją obsługi w odwrotnym kierunku
- RO** 'Pentru dezmembrarea Shedului, Clientul trebuie să urmeze manualul de instrucțiuni în sens invers.'
- BG** 'За демантиране на навеса клиентът трябва да следва инструкциите в наръчник в обратна посока.'
- TR** 'Shed'in sökülmesi için, Müşteri yönergeleri ters yönde takip etmelidir.'











